

INVERTER GENERATOR USER'S MANUAL



GM12000XiT TRI-FUEL INVERTER GENERATOR



12000 STARTING WATTS
10000 RUNNING WATTS



10800 STARTING WATTS
9000 RUNNING WATTS



9600 STARTING WATTS
8000 RUNNING WATTS



WARNING: SAVE THIS MANUAL FOR FUTURE REFERENCE



This manual contains important information regarding safety. Operation, maintenance and storage of this product. Before use, read carefully and understand all cautions, warnings, instructions and product labels. Failure to do so could result in serious personal injury and/or property damage.

**California
Proposition 65 Warning**

The engine exhaust from this product contains chemicals known to the state of California to cause cancer, birth defects or other reproductive harm.

**California
Proposition 65 Warning**

Certain components in this product and its related accessories contain chemicals known to the state of California to cause cancer, birth defects or other reproductive harm. Wash hands after handling.

DISCLAIMERS:

All information, illustrations and specifications in this manual are based on the latest information available at the time of publishing. The illustrations used in this manual are intended as representative reference views only. Moreover, because of our continuous product improvement policy, we may modify information, illustrations and/or specifications to explain and/or exemplify a product, service or maintenance improvement. We reserve the right to make any change at any time without notice. Some images may vary depending upon which model is shown.

ALL RIGHTS RESERVED:

No part of this publication may be reproduced or used in any form by any means - graphic, electronic or mechanical, including photocopying, recording, taping or information storage and retrieval systems - without the written permission of CHONGQING DINKING POWER MACHINERY CO., LTD

 **DANGER**



This manual contains important instructions for operating this inverter generator. For your safety and the safety of others, be sure to read this manual thoroughly before operating the generator. Failure to properly follow all instructions and precautions can cause you and others to be seriously hurt or killed.

UNPACKING

 **CAUTION**



Always have assistance when lifting the generator. The generator is heavy; lifting it could cause bodily harm.



Avoid cutting on or near staples to prevent personal injury.

WHAT COMES IN THE BOX

- Spark Plug Socket Wrench (1)
- Wrench (2)
- Funnel (1)
- Remote Control Key (1)
- Automatic START/STOP Cable (1)
- DC Output Cable (1)
- Adapter (1)
- NG Quick Connector (1)
- NG Hose (1)
- LPG Hose (1)
- Engine Oil (1)

Tools required - box cutter or similar device.

- Carefully cut the packing tape on top of the carton.
- Remove socket wrench, and oil funnel and save for later.
- Carefully cut two sides of the carton to remove the generator.

DESCRIPTION OF FITTINGS

Spark Plug Socket Wrench



Used in spark plug maintenance, inspection, and installation.

Funnel



It's used to oil the generator.

Engine Oil



Be sure to add oil before starting the generator.

Wrench

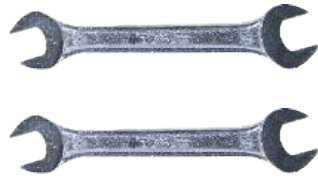

Assorted wrenches used in generator maintenance and assembly.

DC Output Cable



Used to supply power to DC equipment.

Automatic Start/Stop Cable



Used to connect automatic start/stop equipment.

Remote Control Key



Used to remotely start and stop the generator.

NG Quick Connector

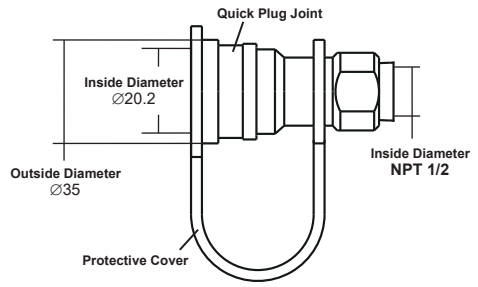
Used to change a natural gas pipeline interface.

LPG Hose



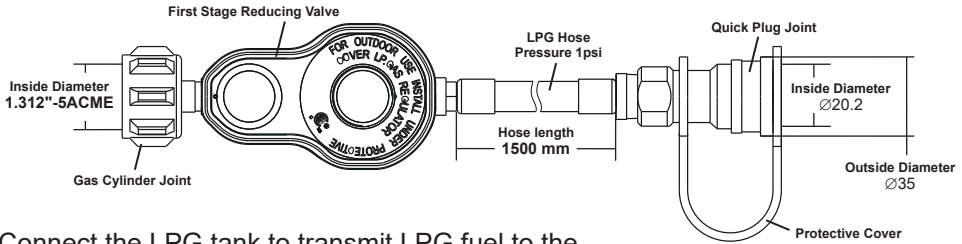

Connect the LPG tank to transmit LPG fuel to the generator.

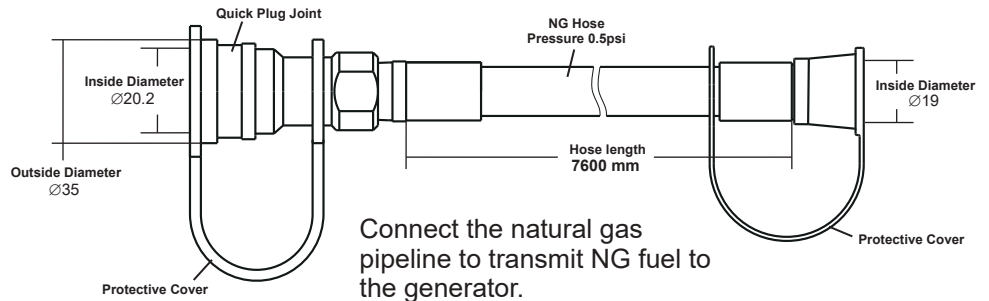
NG Hose

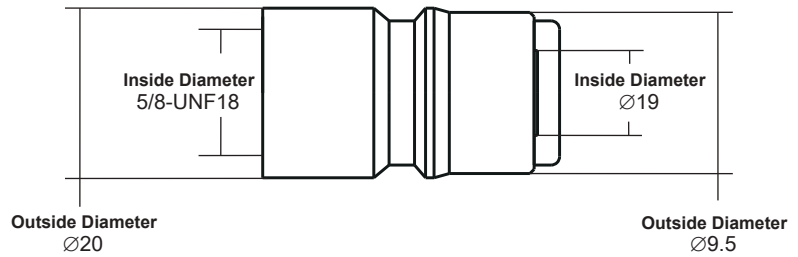

Adapter



Note: Actual tools may differ in appearance or design from image shown.

WARRANTY CARD

PERSONAL INFORMATION

Name: _____

Street Address: _____

City, State, ZIP: _____

Country: _____

Phone Number: _____

E-Mail: _____

INVERTER INFORMATION

Model Number: _____

Serial Number: _____

Date Purchased: _____

Purchased From: _____



TABLE OF CONTENTS

| | |
|---|-----------|
| SAFETY | 6 |
| NAMES OF COMPONENTS | 11 |
| ASSEMBLY | 12 |
| CONTROL FUNCTIONS | 14 |
| PREPARATIONS | 15 |
| Adding Engine Oil..... | 15 |
| Adding Gasoline..... | 15 |
| Connecting an LPG Tank..... | 16 |
| Connect the Natural Gas (NG) Supply Line..... | 17 |
| Connecting The Battery..... | 18 |
| OPERATION | 19 |
| Generator Location..... | 19 |
| Starting the Generator..... | 19 |
| Shutting Down the Generator..... | 23 |
| USING THE GENERATOR | 25 |
| Service Environment of the Generator..... | 25 |
| Generator Wiring..... | 25 |
| Generator Grounding..... | 26 |
| Battery Charging..... | 27 |
| Connecting Automatic Start/Stop Devices..... | 28 |
| SERVICE AND MAINTENANCE | 29 |
| Checking and Filling Fuel..... | 30 |
| Cleaning the generator..... | 30 |
| Spark Plug Inspection..... | 30 |
| Engine Oil Change..... | 31 |
| Cleaning/Replacing the air filter..... | 32 |
| Clean the Fuel Filter..... | 33 |
| STORAGE AND TRANSPORT | 34 |
| Generator Storage..... | 34 |
| Generator Transport..... | 34 |
| Preparation for Use After Storage..... | 34 |
| TROUBLESHOOTING | 35 |
| TECHNICAL PARAMETERS | 37 |
| CHOOSING A GENERATOR | 38 |

SAFETY



Personal and property safeties of you and others are very vital. Please read the Safety Warning in the User's Manual and the decals of the generator set carefully. The Safety Warning can alert you to those potential hazards that could harm you and others. In front of each Safety Warning, there is one of four words "**DANGER**", "**WARNING**", "**ATTENTION**", and "**CAREFUL**". Details are as follows:

DANGER

Failure to follow the instruction will result in being in peril of your life or extremely serious injury.

WARNING

Indicates a hazardous situation which, if not avoided, could result in death or serious injury.

CAREFUL

Failure to follow the instruction will result in minor injury.

ATTENTION

Failure to follow the instruction will result in the damage to your generator set and other properties.

CO TECHNICAL WARNING

CO DETECT technology monitors the accumulation of carbon monoxide (CO), a poisonous gas produced by engine exhaust when the generator is running. If CO Sensor detects unsafe elevated levels of CO gas, it automatically shuts off the engine. CO Sensor is not a substitute for an indoor carbon monoxide alarm or for safe operation. **DO NOT** allow engine exhaust fumes to enter a confined area through windows, doors, vents or other openings. Generators must **ALWAYS** be used outdoors, far away from occupied buildings with engine exhaust pointed away from people and buildings. Meets the requirements of ANSI/PGMA G300-2023.

SAFETY PRECAUTIONS

DANGER

Using a generator indoors CAN KILL YOU IN MINUTES. Generator exhaust contains carbon monoxide. This is a poison you cannot see or smell.



NEVER use inside a home or garage, EVEN IF doors and windows are open.



Only use OUTSIDE and far away from windows, doors, and vents.

WARNING

POISONOUS GAS HAZARD

Engine exhaust contains carbon monoxide, a poisonous gas that could kill you in minutes. You **CANNOT** smell it, see it, or taste it. Even if you do not smell exhaust fumes, you could still be exposed to carbon monoxide gas.

- Operate this product **ONLY** outside far away from windows, doors and vents to reduce the risk of carbon monoxide gas from accumulating and potentially being drawn towards occupied spaces.
- Install battery-operated carbon monoxide alarms or plug-in carbon monoxide alarms with battery back-up according to the manufacturer's instructions. Smoke alarms cannot detect carbon monoxide gas.

SAFETY

- DO NOT run this product inside homes, garages, basements, crawlspaces, sheds, or other partially-enclosed spaces even if using fans or opening doors and windows for ventilation. Carbon monoxide can quickly build up in these spaces and can linger for hours, even after this product has shut off.
- ALWAYS place this product downwind and point the engine exhaust away from occupied spaces. If you start to feel sick, dizzy, or weak while using this product, shut it off and get to fresh air RIGHT AWAY. See a doctor. You may have carbon monoxide poisoning.
- If you start to feel sick, dizzy or weak while using the portable generator, you may have carbon monoxide poisoning. Get out side to fresh air immediately and emergency medical assistance.. Very high levels of CO can rapidly cause victims to lose consciousness before they can rescue themselves. DO NOT attempt to shut off the generator before moving to fresh air. Entering an enclosed space where a generator is or has been running may put you at greater risk of CO poisoning.

CO Sentry Indicator Lights

Red

Carbon monoxide has accumulated around the generator. After shut-off, the RED indicator light in the CO Sentry area of the control panel will flash to provide notification that the generator was shutdown due to an accumulating CO hazard. The RED light will flash for at least five minutes after a CO shut-off. Move the generator to an open, outdoor area far away from occupied spaces with exhaust pointed away. Once relocated to a safe area, the generator can be restarted. Introduce fresh air and ventilate the area where the generator had shut down.

Yellow

A CO Sentry system fault occurred. When a system fault occurs, the generator is automatically shut down and the YELLOW indicator light in the CO auto-shutoff area of the control panel will flash to provide notification that a fault has occurred. The YELLOW light will flash for at least five minutes after a fault. The generator can be re-started, but may continue to shutoff.

CORRECT USAGE

Example location to reduce risk of carbon monoxide poisoning

- ONLY use outside and downwind, far away from windows, doors and vents.
- Direct exhaust away from occupied spaces.

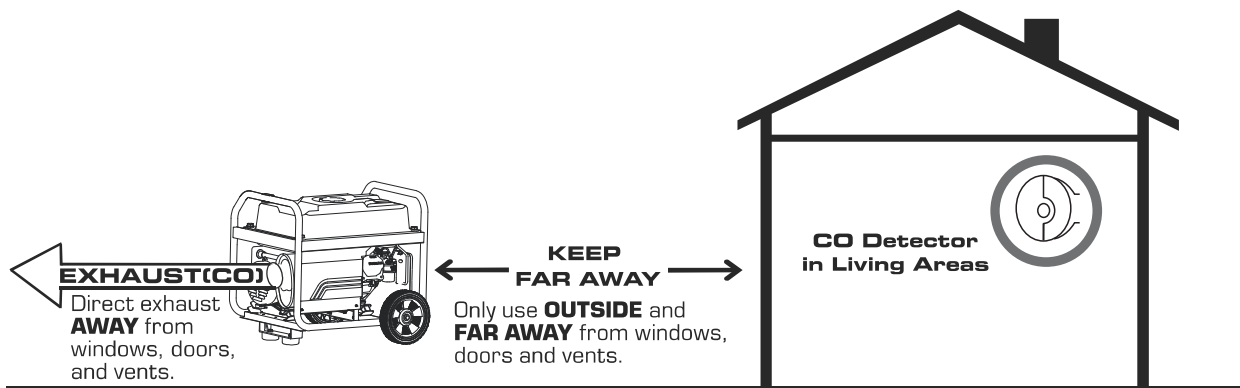

INCORRECT USAGE

Do not operate in any of the following locations:

Near any door, window or vent
 Garage
 Basement
 Crawl Space
 Living Area
 Attic
 Entry Way
 Porch
 Mudroom

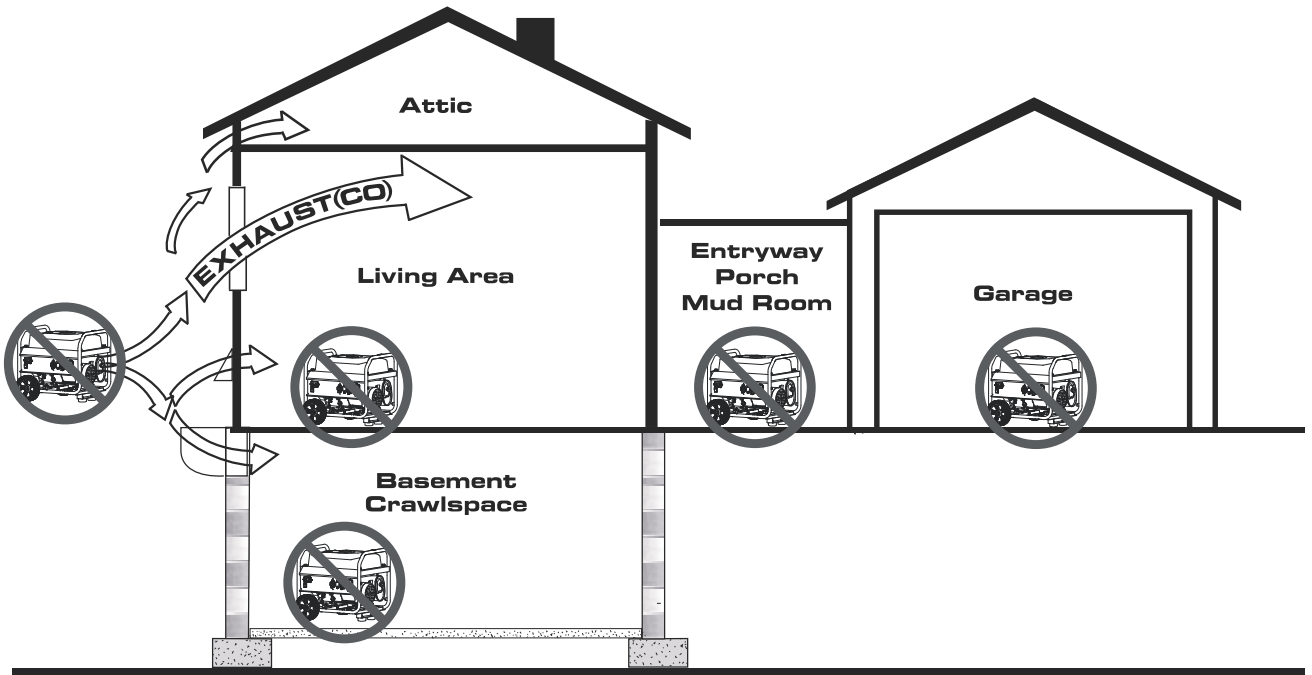

BEFORE USING THE GENERATOR

- In order to operate the generator correctly, be familiar with the operation of the various components and master the method of shutting down the generator quickly.
- Never use the generator to power medical support equipment.
- Please never modify the generator.
- Please do not use in rain or in areas with water. There is a risk of electric shock when using generators and connected appliances that have been soaked in rain or water, or when operating with wet hands.
- Please never connect wires from the power company. It can cause malfunctions in the machine and connected electrical equipment, becoming the cause of fire or personal accidents.

- The use of generators has laws and regulations, please comply with labor safety and health regulations, fire protection laws, electrical industry laws, etc.
- Please do not connect parallel operation terminals except for dedicated wires. There is a risk of electric shock.

WHEN ADDING OR DRAINING GASOLINE

Turn the generator engine OFF and let it cool for at least 2 minutes before removing the fuel cap. Loosen the cap slowly to relieve pressure in the tank.

- Fill or drain fuel tank outdoors.
- DO NOT overfill the tank. Allow space for fuel expansion.
- If fuel spills, wipe it up and let the area dry before starting the engine.

SAFETY

- Keep fuel away from sparks, open flames, heat, and other ignition sources.
- Check fuel lines, tank, cap, and fittings frequently for cracks or leaks; replace if necessary.
- DO NOT light a cigarette or smoke anything.

WHEN STARTING EQUIPMENT

- Ensure spark plug, muffler, fuel cap, and air cleaner are in place.
- DO NOT crank engine with spark plug removed.

WHEN OPERATING EQUIPMENT

- DO NOT operate this product inside any building, carport, porch, mobile enclosure, marine applications, or shed.
- DO NOT tip engine or equipment at an angle that causes fuel to spill.
- DO NOT stop the engine by moving the choke control to the "Start" position.
- DO NOT exceed the generator's wattage capacity.
- Start the generator and let the engine stabilize before connecting electrical loads.
- Connect electrical loads in the OFF position, then turn ON for operation.
- Turn electrical loads OFF and disconnect from the generator before stopping the generator.

ATTENTION

Improper treatment of the generator could damage it and shorten its life.

- Use generator only for intended applications.
- If you have questions about intended use, ask a dealer.
- Operate generator only on solid, level surfaces.
- DO NOT expose the generator to excessive moisture, dust, dirt, or corrosive vapors.
- DO NOT insert any objects through cooling slots.
- If connected devices overheat, turn them off and disconnect them from the generator.

PARALLEL KIT PRECAUTIONS

To prevent serious injury, death and damage to generators and/or equipment due to electric shock and fire:

- Follow Parallel Kit instructions provided with Kit for connection and use of a Parallel Kit.
- Only connect two identical Inverter Generators together using a Parallel Kit.

- Connect Parallel Kit only to terminals marked "Parallel Outlets" on the front of the Generator.
- Do not remove or connect a Parallel Kit while the Generator is running.
- Do not use a Parallel Kit that is attached to only one Generator.

SAFETY PRECAUTIONS FOR GASOLINE AND GASOLINE VAPOR

- Fire and explosion hazard. Gasoline is highly explosive and flammable and can cause severe burns or death.
- Fire and Burn Hazard. NEVER loosen or remove the fuel cap while the generator is running. Turn the unit off and allow it to cool for at least five minutes before adding gasoline. Loosen the fuel cap slowly.
- In case of a gasoline fire, do not attempt to extinguish the flame unless the engine/fuel control switch is in the OFF position. Introducing an extinguisher to a generator with an open fuel valve could create an explosion hazard.

LIQUID PETROLEUM GAS (LPG/PROPANE)

Fire and explosion hazard. Never use a gas container, LPG/propane hose, propane cylinder or any other fuel item that appears to be damaged. If there is a strong smell of propane while operating the generator, fully close the propane cylinder valve immediately. Once the propane is off, use soapy water to check for leaks on the hose and connections on the tank valve and the generator. Do not smoke or light a cigarette or check for leaks using any open flame source such as a match or lighter. If a leak is found, contact a qualified technician to inspect and repair the LPG/propane system before using the generator.

NATURAL GAS (NG)

Fire and explosion hazard. Never use a natural gas supply line, natural gas hose, or any other fuel item that appears to be damaged. If there is a strong smell of natural gas while operating the generator, close off all gas sources immediately. Once the natural gas is off, use soapy water to check for leaks on the hose and connections on the branch supply and the generator. Do not smoke or light a cigarette or check for leaks using any open flame source such as a match or lighter. If a leak is found, contact a qualified plumber to inspect and repair the natural gas system before using the generator.

SAFETY

SAFETY LABELS AND DECALS



1

WARNING
HOT SURFACE

AVERTISSEMENT
SURFACES TRES CHAUDE

ADVERTENCIA
SUPERFICIES CALIENTE

2

| GM12500XIT | | TRI-FUEL Inverter Generator | |
|--------------|------------------|--|-----------|
| AC Voltage: | 120/240V | Phase: | Single |
| Current: | 83.3/41.7A - GAS | RPM: | 3800 |
| | 75/37.5A - LPG | Power Factor: | 1.0 |
| | 66.7/33.3A - NG | Insulation Class: | F |
| Frequency: | 60Hz | Rated Amb. Temp.: | 77°F/25°C |
| Rated Power: | 10kW - GAS | GENMAX | |
| | 9kW - LPG | | |
| | 8kW - NG | CHONGQING DINKING POWER MACHINERY CO.,LTD. | |
| DC Output: | 12V 8.3A | | |

3

⚠️ AUTOMATIC SHUTOFF-YOU MUST:

MOVE GENERATOR TO AN OPEN,OUTDOOR AREA. POINT EXHAUST AWAY.DONT RUN GENERATOR IN ENCLOSED AREAS(E.G. NOT IN HOUSE OR GARAGE).

+ MOVE TO FRESH AIR AND GET MEDICAL HELP IF SICK, DIZZY OR WEAK.

4

⚠️ DANGER

Using a generator indoors CAN KILL YOU IN MINUTES. Generator exhaust contains carbon monoxide. This is a poison you cannot see or smell.

NEVER use inside a home or garage, **EVEN IF** doors and windows are open.

Only use OUTSIDE and far away from windows, doors, and vents.

5

⚠️ DANGER Risk of fire. Check for any fuel overflow or leakage. Stop the engine before refueling. / Riesgo de incendio. Revise si hay algún derrame o fuga de combustible. Apague el motor antes de poner combustible. / Risque d'incendie. Verifiez tout debordement ou fuite de carburant. Arrêtez le moteur avant le remplissage.

⚠️ PELIGRO Failure to properly ground generator can result in electrocution, especially if the generator is equipped with a wheel kit. / La omisión de conectar a tierra adecuadamente el generador puede resultar en electrocución, especialmente si el generador está equipado con un kit de ruedas. / Le défaut de mise à la terre correcte du générateur peut entraîner l'électrocution, surtout si le générateur est équipé d'un kit de roue.

⚠️ DANGER Generator is a potential source of electric shock. Do not expose to moisture/rain/snow or use in damp location. Do not operate with wet hands or feet. / El generador es una fuente de descarga eléctrica. No exponga a la humedad/la lluvia/la nieve o utilice en lugares húmedos. No opere con manos o pies húmedos. / Le générateur représente un danger potentiel d'électrocution. Ne pas être exposé à l'humidité/à la pluie/à la neige ou à utiliser dans des endroits humides. Ne l'utilisez pas avec les mains ou les pieds mouillés.

⚠️ DANGER Exhaust contains poisonous carbon monoxide gas that can cause unconsciousness or DEATH. Operate in well ventilated, outdoor areas away from open windows or doors. / El escape contiene gas venenoso de monóxido de carbono que puede causar pérdida del conocimiento o MUERTE. Opere en áreas exteriores bien ventiladas lejos de puertas o ventanas abiertas. / Les gaz d'échappement contiennent notamment du monoxyde de carbone toxique qui peut provoquer l'inconscience ou la MORT. Opérez dans des zones à l'extérieur bien ventilées, loin de portes ou fenêtres ouvertes.

You could be killed or seriously hurt if you do not follow the Operator's Manual instructions. / SE MATARÁ O LESIONARÁ GRAVEMENTE si no sigue las instrucciones del manual operador. / Vous s'erez TUE ou SÉRIEUSEMENT BLESSÉ si vous ne suivez pas les instructions du Manuel de l'Opérateur.

NAMES OF COMPONENTS



- ① **Recoil Handle:** Use the recoil handle to manually start the generator.
- ② **NG/LPG Inlet:** Connect LPG (propane) or NG (methane) as fuel.
- ③ **Control Panel:** Contains the reset breaker, outlets and warning lights.
- ④ **Muffler:** Avoid contact until the engine is cooled down. The spark arrestor prevents sparks from exiting the muffler. It must be removed for servicing.
- ⑤ **Oil Dipstick:** Unscrew the oil dipstick to check oil levels and add oil when needed.
- ⑥ **Wheel**
- ⑦ **Battery:** Power is supplied when the generator starts. 6DM6.5 12V 6.5Ah 10Hr
- ⑧ **Handle**
- ⑨ **Inverter:** Conversion of direct current to alternating current using high frequency bridge circuit.
- ⑩ **Fuel Source Switch:** Choice of fuel source.
- ⑪ **Air Cleaner:** To purify the waste gas.
- ⑫ **Carburetor**
- ⑬ **Cylinder Head**
- ⑭ **Spark Plug**
- ⑮ **Fuel Tank:** Store the added gasoline.
- ⑯ **Fuel Tank Cap:** Open the fuel tank cap and fill with proper amount of gasoline.
- ⑰ **Fuel Switch:** Rotate to ON to turn on gasoline, rotate to OFF to turn off gasoline.
- ⑱ **Fuel Gauge**

ASSEMBLY

WARNING

Weight hazard. Always have assistance when lifting the generator. Never attempt to lift the unit by the handle. Hold the unit by the frame and use proper lifting techniques to reduce the risk of back injury.

This product requires assembly. Do not attempt to operate this product if any items in the INCLUDED LIST are already assembled when you remove the carton contents. These items are not assembled by the manufacturer and should require customer assembly. Using an improperly assembled product can be hazardous and could result in serious personal injury.

- Carefully cut down the sides of the packaging and remove the carton contents.
- Inspect the carton contents. Verify that all the items in the INCLUDED LIST are present and undamaged.
- Recycle or dispose of the packaging materials properly.

DANGER

Pinch point hazard. Do not place your hand or fingers between the handle and the generator's frame.

WARNING

Do not alter or modify this product unless instructed to so in this manual or by the manufacturer. Do not use attachments or accessories that are not recommended for use with this product. Making unauthorized modifications and using incompatible accessories can damage the unit and void your warranty.

ASSEMBLY

Installing Support Leg

- Parts needed - Support Leg $\times 2$, M8 $\times 16$ screw $\times 4$, M8 Nut $\times 4$.
- Raise the front end of the generator high enough to gain access to the bottom of the frame. Securely position props underneath to support.
- Line up holes on the support leg bracket to the holes on the front of the generator frame.
- Attach the support leg using screws and nuts.

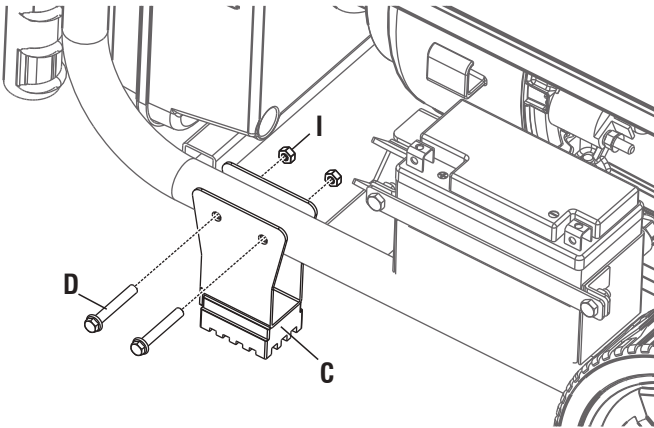

Installing Wheels

- Parts needed - Wheels $\times 2$, Axles $\times 2$, Hitch Pins $\times 2$.
- Raise or tilt generator so you can slide the wheel axle pin into the wheel, the washer, the wheel mounting hole located on the side of the frame.
- Secure the wheel assembly by reinserting a hitch pin through hole at the end of the wheel axle and pressing until it locks into place.
- Repeat process on the other side of the generator to install the second wheel.

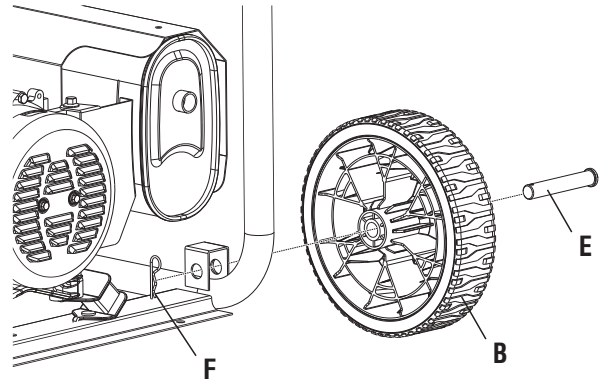

Installing the Handle

- Parts needed - Handle $\times 2$, M8 $\times 50$ Screw $\times 2$, M8 Nut $\times 2$, Rubber Washer $\times 4$.
- Positioning handle, rubber gasket and bolt.
- Push the bolts one by one through the holes in the handle, the rubber washer, the frame and the rubber washer.
- Tighten nuts securely. Do not over tighten.
- Repeat these steps to install second handle.

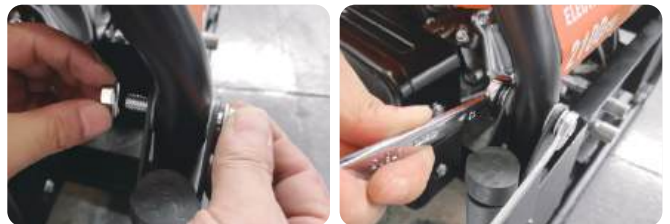
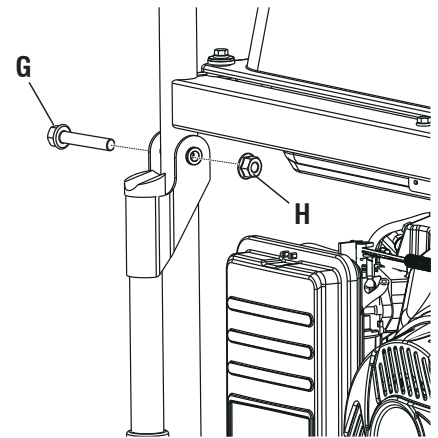

CONTROL FUNCTIONS

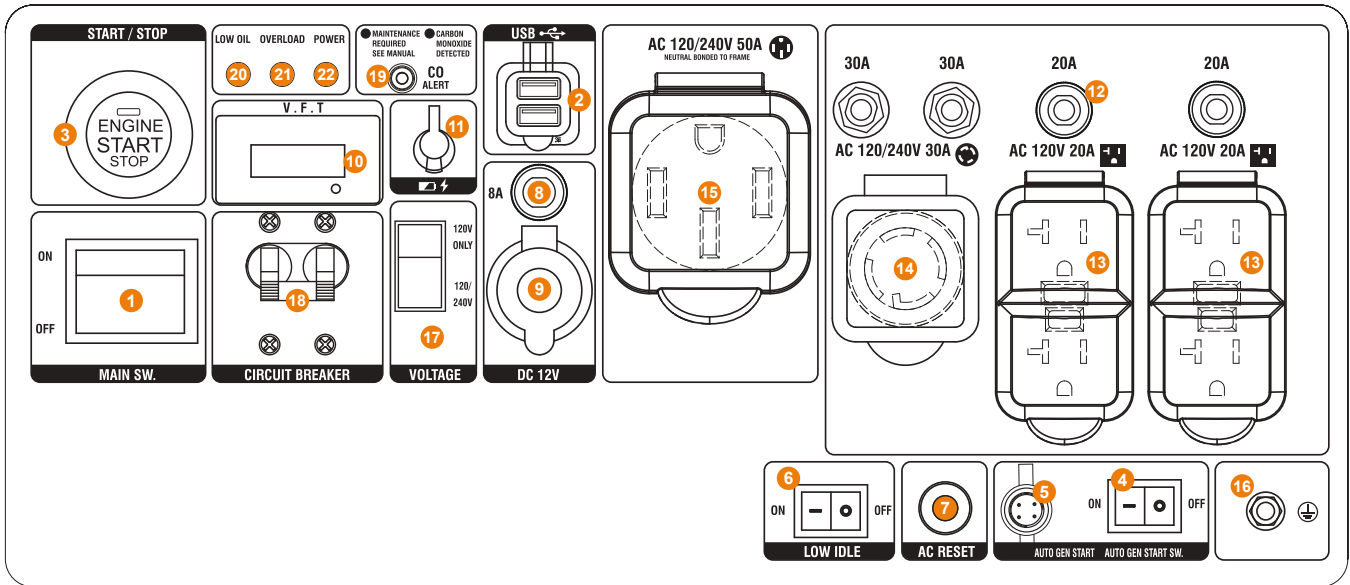

CONTROL PANEL FEATURES

- ① **Main Switch:** Manage battery power and shutdown.
Tip: If you do not use the generator for more than 7 days (168 hours), please press the main switch to the "OFF" position, which can prevent the battery from running out.
- ② **USB Duplex:** 5V DC that come in 1 amps and 2.1 amps.
- ③ **Start/Stop Button:** Press this button, the engine can start and stop.
- ④ **AUTO GEN START SW.:** Connect the automatic start/stop device to the communication interface ⑤ through the automatic start/stop connection line, and press this switch to the ON position. The generator will be controlled by an external device with automatic start/stop function. After this function is enabled, the push start button and remote start start/stop button and remote start are disabled.
- ⑤ **AUTO GEN START:** The communication interface for automatically starting and stopping the generator. Used to connect equipment with automatic start stop function.
- ⑥ **Low Idle:** When turned to the ON position, the engine will sense the load needed and run at a slower RPM to save fuel.
- ⑦ **Reset:** If the generator is overloaded, the reset breaker will trip. The engine will continue to run, but there will be no output from the generator. Unplug the devices and reduce the load. Push in the reset breaker to reset it.
- ⑧ **DC Protector:** If the generator is overload, the DC protector will trip to block current.
- ⑨ **DC Cigarette Lighter Outlet:** 12V DC 8.3A.
- ⑩ **Three in one Digital Display Table:** Voltage, frequency, time display, press the button to switch.
- ⑪ **Battery Charging Port:** Charge the generator battery.
- ⑫ **AC Breakers:** The circuit breakers protect individual circuits from electrical overload.
- ⑬ **120V AC 20A 5-20R Outlet:** The outlet is capable of carrying a maximum of 20 amps.
- ⑭ **120/240V AC 30A L14-30R Outlet:** The outlet is capable of carrying a maximum of 30 amps.
- ⑮ **120/240V AC 50A 14-50R Outlet:** Receptacle can supply a maximum of 50 Amps.
- ⑯ **Ground Terminal:** The ground terminal is used to externally ground the generator.
- ⑰ **Voltage Switch:** Switch between 120V and 240V voltage as required.
- ⑱ **Circuit Breaker:** A circuit breaker interrupts the current when the whole circuit is overloaded.
- ⑲ **CO Alarm:** Flashing red light: dangerous levels of carbon monoxide gas have built up leave immediately until area has aired out. Move generator to well-ventilated area before operation. Flashing yellow light: carbon monoxide sensor malfunction. Sensor needs service.
- ⑳ **Low Oil Alarm:** Indicates low oil level.
- ㉑ **Overload Alarm:** Indicates that the inverter is overloaded.
- ㉒ **Output Indicator:** Indicates the inverter is ready to be used.

PREPARATIONS

ADDING ENGINE OIL

WARNING

No oil is filled into this generator when being delivered. Do not start up the generator without filling sufficient oil.

ATTENTION

Your generator was functionally tested in the factory and may contain minimum residual oil. Additional oil is required to operate the unit. Do not overfill.

The recommended oil type for typical use is 10W-30 automotive oil. However, using the listed conventional oils shown in the "Recommended Engine Oil Type" chart may be used for typical use including the first 5 hours of the break-in run time period of the engine. If running generator in extreme temperatures, refer to the "Recommended Engine Oil Type" chart.

| Recommended Engine Oil Type | |
|-----------------------------|--|
| | 10W-30 |
| | 5W-30 |
| | 10W-40 |
| | 5W-30 Full Synthetic |
| °C | -20 0 20 40 60 80 100 120 |
| °F | -28.9 -17.8 -6.7 4.4 15.6 26.7 37.8 48.9 |
| Ambient Temperature | |

1. Please place the generator onto a horizontal plane surface.

2. Slowly unscrew and remove the oil dipstick.



3. Using a funnel, as needed, add the appropriate type of oil until the oil level is at the proper level.

SAE 10W-30 oil is recommended for general use. DO NOT OVERFILL. Replace oil fill cap/dipstick and secure maintenance cover.



4. Check engine oil level daily and add as needed.

Reinsert the dipstick, but do not tighten it, and remove it again to check the oil level. The oil level should reach the full liquid level as shown in the figure.

5. After refueling, tighten the oil dipstick, wipe off the surrounding oil.

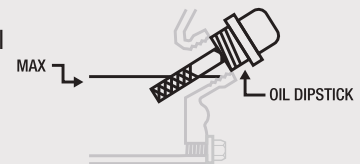

ADDING GASOLINE

WARNING



TO PREVENT SERIOUS INJURY FROM FIRE:

Fill the gasoline tank in a well-ventilated area away from ignition sources. If the engine is hot from use, shut the engine off and wait for it to cool before adding gasoline. Do not smoke.

PREPARATIONS

1. Make sure the generator is on a solid, flat, level surface.
2. Unscrew the fuel cap and set it aside.
3. Slowly add gasoline to the fuel tank. Be careful not to overfill.
4. Replace the fuel cap and wipe up any spilled gasoline with a dry cloth then remove the cloth from the area.



⚠ DANGER

Do not overfill the gasoline the tank. Overfilling can result in a fire, explosion, or death.

⚠ WARNING

Gasoline can expand. Do not fill the gasoline tank to the top. Leave a minimum of 1.5 inches open space. Gasoline fumes are highly flammable. Do not fill the tank near an open flame. Always check for gasoline spills.

- ALWAYS use CLEAN, FRESH, unleaded gasoline (87–93 octane) in this unit. NEVER use OLD, STALE, or CONTAMINATED gasoline.
- Never use an oil/gasoline mixture.
- Avoid getting dirt or water in the gasoline tank.
- Gasoline can age in the tank and make it hard to start the generator in the future.
- Never store generator for extended periods of time with gasoline in the tank.
- Wipe up any spilled fuel and allow excess to evaporate before starting the engine. To prevent FIRE, do not start the engine while the smell of fuel hangs in the air.



CONNECTING AN LPG TANK

ATTENTION

- Confirm that the re-qualification date on the tank has not expired.
- All new propane tanks must be purged of air and moisture prior to filling. Used propane tanks that have not been plugged or kept closed must also be purged. The purging process should be done by a propane tank supplier (propane tanks from an exchange supplier should have been purged and filled properly).
- ALWAYS position the propane tank so the connection between the valve and the gas inlet will not cause sharp bends or kinks in the hose.

⚠ DANGER

Explosion hazard. DO NOT start generator if you smell propane. ALWAYS fully close the propane tank valve and disconnect the LPG hose from the generator when not in use.

1. Turn the generator OFF and place on a flat surface in a well ventilated area.
2. Verify that the LPG tank valve is in the fully closed position.



PREPARATIONS

3. Remove the cover on the generator propane inlet.
4. Screw the Adapter onto the LPG/NG inlet.



5. Tighten the LPG hose to the LPG/NG inlet of the generator.
IMPORTANT: DO NOT use thread seal tape or any other type of sealant to seal the LPG hose connection.
Push back the quick connector collet of the LPG hose, insert it into the generator LPG/NG inlet, loosen the quick connector sleeve, and make the sleeve clamp the propane/methane inlet.



6. Remove the safety plug or cap from the LPG tank valve and attach the other end of the hose to the LPG connector on the tank. Hand-tighten.



7. Turn the LPG tank valve to the fully open position.
Check all connections for leaks by wetting the fittings with a solution of soap and water. Bubbles which appear or bubbles which grow indicate that a leak exists. If a leak exists at a fitting, turn the LPG tank valve to the fully closed position and tighten the fitting. Open the LPG tank valve and recheck the fitting with the soap and water solution.



CONNECT THE NATURAL GAS (NG) SUPPLY LINE

⚠ DANGER

Fire and explosion hazard. Never connect or disconnect the natural gas hose while the engine is running. Do not smoke or create sparks while handling natural gas. Always turn the engine off and allow the generator to cool for at least five minutes before connecting to natural gas.

⚠ WARNING

- Never use a natural gas supply line, natural gas hose, or any other fuel item that appears to be damaged.
- To reduce the risk of injury, perform a leak test any time the natural gas hose is disconnected and reconnected.
- Explosion hazard. If you smell methane, do not start the generator. Always completely close natural gas supply line valve and disconnect natural gas (NG) hose from generator when not in use.

1. Turn the generator off and allow the engine to cool for at least five minutes.
2. Verify that the gas is turned off at the natural gas supply line.

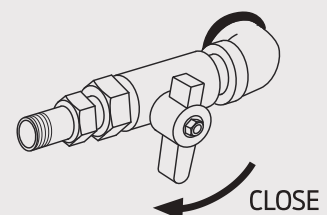

PREPARATIONS

3. Screw the Natural Gas Adapter onto the natural gas supply line.

Contact your local gas company for guidance on accessory connection to a natural gas line. Your qualified contractor must minimally ensure the pipe supply line threads are clean and in good condition. Pipe connections must be made using a gas rated 'dope' or PTFE tape.



4. Connect the natural gas hose to the natural gas supply line.

Pull the quick connect collet rearward, insert the natural gas hose nipple, then release the collet; ensure a solid connection is made.



5. Tighten the other end of the natural gas hose to the LPG/NG inlet of the generator.

Push back the quick connector collet of the natural gas hose, insert it into the generator LPG/NG inlet, loosen the quick connector sleeve, and make the sleeve clamp the propane/methane inlet.

IMPORTANT: DO NOT use thread seal tape or any other type of sealant to seal the natural gas hose connection.



6. Turn the natural gas (NG) supply line valve to the fully open position.

Check all connections for leaks by wetting the fittings with a solution of soap and water. Bubbles which appear or bubbles which grow indicate that a leak exists. If a leak exists at a fitting, turn the natural gas (NG) supply line valve to the fully closed position and tighten the fitting. Open the natural gas (NG) supply line valve and recheck the fitting with the soap and water solution.

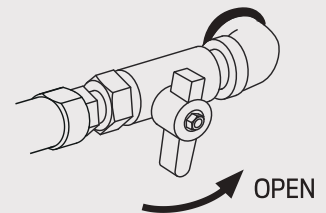

CONNECTING THE BATTERY

Connect the positive and negative electrodes of the battery.

A quick-connect battery plug is pre-installed on the battery. Remove the cable tie securing the plugs, align colors, then push firmly to connect them.



Note: The generator is equipped with a battery charging feature. Once the engine is running, a small current will slowly recharge the battery.

GENERATOR LOCATION

WARNING

- **NEVER** operate the generator inside any building, garage, basement, crawlspace, shed, or enclosure, including the generator compartment of a recreational vehicle.
- **NEVER** operate or start the generator in the back of an SUV, camper, trailer, truck bed (regular sides, flat or other configuration), under staircases, stairwells, next to walls or buildings, or any other location that could limit airflow or trap exhaust.
- **DO NOT** operate or store the generator in wet weather conditions such as rain or snow. Using a generator in wet conditions could result in serious injury or death due to electrocution.
- Generators must have a minimum of 5 feet (1.5 m) of clearance from all combustibile material.
- Generators must also have a minimum of 5 feet (1.5 m) of airflow clearance on all sides to allow for adequate cooling, maintenance, and service.
- Always place the generator in a well-ventilated area. **NEVER** place the generator near air intake vents or where exhaust fumes could be drawn into occupied or confined spaces.
- Always carefully consider wind and air currents when positioning the generator.
- Always allow generators to properly cool before transport or for storage purposes.
- Failure to follow proper safety precautions may result in personal injury, damage to the generator, and void your warranty.

WARNING

During operation, the muffler and exhaust fumes will become hot. If there is inadequate cooling space or if the generator is blocked or enclosed, temperatures can rise quickly and may lead to a fire.

STARTING THE GENERATOR

1. **Make sure the generator is on a solid, flat, level surface.**
2. **Disconnect all electrical loads from the generator. Never start or stop the generator with electrical devices plugged in or turned on.**

3. **Turn the Fuel Switch to desired fuel source.**

To switch to gasoline

- Add gasoline.
- Turn off the flow of natural or propane gas.
- Turn the fuel switch to "ON".
- Turn the Fuel Source Switch to the Gasoline position.

To switch to propane

- Open the cylinder valve on the LPG cylinder to start the flow of propane.
- Turn off the flow of natural gas and gasoline.
- Turn the Fuel Source Switch to the Propane(LPG) position.

To switch to natural gas

- Open the valve on the natural gas supply line to start the flow of natural gas.
- Turn off the flow of propane and gasoline.
- Turn the Fuel Source Switch to the Natural Gas(NG) position.



OPERATION

4. Check whether the **AUTO GEN START** Switch is in the "OFF" position. If this switch is in the ON position, the start button and remote start/stop button will be disabled.



5. Press the **LOW IDLE** Switch to "OFF".

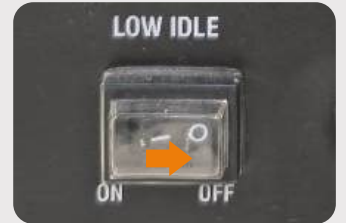

6. Press the **Main Switch** to "ON".

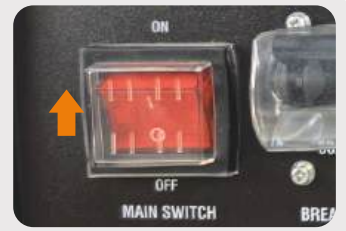

7. Choose the Starting Method

a. Recoil Start

Firmly grasp and pull the recoil handle slowly until you feel resistance, let it retract then pull swiftly.

b. Push Button Start

Press the start button for 1-3 seconds, then release, to start the generator.

c. Remote Start

Push and hold the ON button on the remote start key fob for one second.

NOTE: If the generator is not successfully started using buttons/electric start and remote start, the battery of the generator may need to be charged. Use recoil to start the generator. The battery of the generator will be charged during the operation of the unit. Or use a power adapter to connect to the battery charging port on the panel to charge the battery.



8. Place the **Circuit Breaker Switch** in the "ON" position.



OPERATION

9. After 1-2 minutes of normal operation of the generator, connect the required equipment.



DANGER

Fire and explosion hazard. Always turn the propane(or methane) tank valve to the fully closed position if not running the generator on propane(or methane).

WARNING

When using the generator with propane(or methane), make sure there is no possible ignition source close to the generator.

Gasoline to LPG/NG

IMPORTANT: Load capacity is reduced when running on LPG/NG. Make sure the generator can supply enough (running) and surge (starting) watts for the items you are powering before switching to LPG/NG.

1. Turn the LPG tank valve(natural gas supply line valve) to the fully open position.
2. Turn the fuel selector switch to LPG/NG operation.

LPG/NG to Gasoline

1. Turn the fuel selector switch to gasoline operation.
2. Turn the LPG tank valve(natural gas supply line valve) to the fully closed position.

NOTE: When switching to another fuel operation, the engine may run violently for a few seconds.

If the engine stops when switching fuel sources, disconnect all loads then restart the unit on the fuel source of choice.

COMMON PROBLEMS WITH STARTING THE GENERATOR:

Start the generator to run normally without output ?

1. Check whether the green light of the GFCI socket is on.

If the green light is not on, press the RESET button after the generator is started to make the green light on.

Tip: When the generator is not started, the GFCI socket is in the protected state and the "RESET" button cannot be pressed.



2. Check whether the circuit breaker switch is set to "ON".

If the circuit breaker switch is set to ON and there is no output, press the heat protection corresponding to the socket and use a multimeter to test whether the socket has voltage.



OPERATION

LPG/NG start up is difficult ?

When both gasoline and LPG/NG are present in the generator it is recommended to start the generator on gasoline first, allow the engine to stabilize then switch to LPG(or NG).

1. Ensure the LPG (or NG) supply hose is securely attached and Close the LPG (or NG) valve completely.



2. Fuel source rocker switch to "GASOLINE".
3. Follow the startup steps to start the generator.



4. Open the LPG (or NG) valve completely.



5. Fuel source switch to "LPG (or NG)".



Electric start and remote start no response ?

1. Check whether the positive and negative electrodes of the battery are correctly connected.
2. Check whether the battery is charged.
3. Check whether the remote control is powered on.

Remote Control Pairing

1. Long press the start button for more than 5 seconds until the button red indicator is on;
2. Press any key on the remote control;
3. The red indicator of the start button will blink two or three times and then turns off, Remote start pairing is successful.

Tip: The remote control delivered with the generator has been paired successfully.

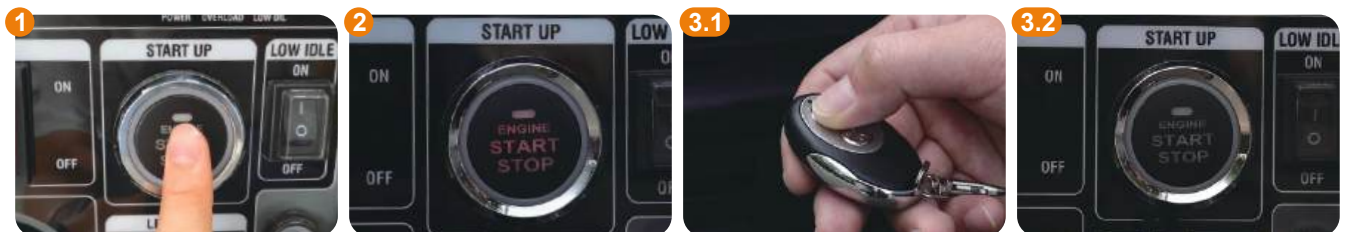

OPERATION

TIP

Remote Control Key Dormancy

When generator stops running for 5 days (120hours), while the main switch is not turned off, the remote control key cannot be used to start the generator again. At this time, you need to turn off the main switch and turn it on again, or press the one-key start button (or hand start) to start the generator, and the remote control key will be reactivated.

Parallel Operation

The parallel connection ports allow you to connect two generators to increase the total available electrical power. Follow the instructions included with your parallel connection kit for proper installation and operation.

Overload Indicator

Note: The OVERLOAD light may turn on for a few seconds as a large device starts. This is normal for loads approaching the capacity of this generator.

1. The total combined load through the outlets on the generator must not exceed the running power of the unit.
2. If the OVERLOAD light turns on and the generator stops producing power, it has been overloaded.
3. Turn off and disconnect all electrical devices and stop the engine. Compare device requirements to generator rating and reduce the total wattage of connected devices if necessary. Move anything that may be limiting generator ventilation away.
4. Check if any circuit breakers have tripped and make sure that ALL circuit breakers are reset before starting the generator again.
5. Restart the engine and reconnect devices while being careful to not overload the generator.

Low Oil Indicator

1. If the engine oil level is too low, the LOW OIL light turns on and the engine will automatically shut off.
2. The engine cannot be restarted until the proper amount of oil has been added. Add the appropriate type of oil until the oil level is at the proper level. SAE 10w-30 oil is recommended for general use.

ATTENTION

Do not run the engine with too little oil. Engine will shut off if engine oil level is too low.

Low Idle

1. Turn on a low idle mode to limit noise and fuel consumption with a light generator load.
2. Turn off the low idle mode to run the engine at full speed under the following conditions:
 - Starting the generator.
 - If the load exceeds 50%, it is recommended to turn off the low idle mode.

Voltage Selector

The Voltage Selector allows more current to be available at 120V outlets if 240V output is not required:

- Switch to 120V only: 120V sockets and 120V/240V dual voltage sockets can be used, but 120V/240V dual voltage sockets can only output 120V.
- Switch to 120V/240V: Both 120V and 240V outlets can be used.

NOTE: Do not change the switch while under load. For parallel function, switch position must be at 120/240V.

SHUTTING DOWN THE GENERATOR

1. Turn off and unplug all connected electrical loads. Never start or stop the generator with electrical devices plugged in or turned on.

OPERATION

2. Select the Stopping Mode

a. Button Stop

Press the button to turn off the generator.

b. Remote Stop

Press the "OFF" button on the remote control for 1-3 seconds.

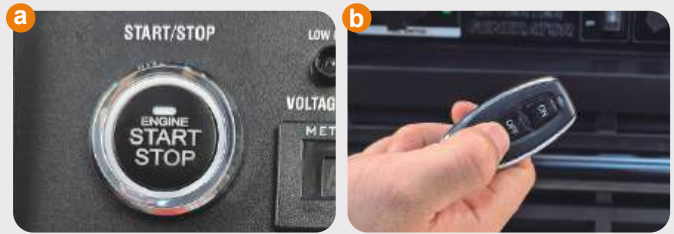

If not used for a long time, please perform the following operations

3. Press the Main Switch to "OFF".

Tip: If you do not use the generator for more than 7 days (168 hours), please press the main switch to the "OFF" position, which can prevent the battery from running out.

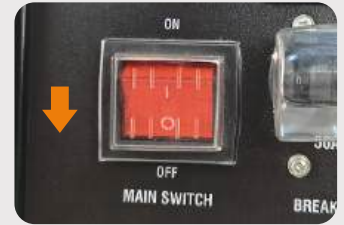

4. Turn the Fuel Source Switch to the "OFF" position.

5. Stop the flow of fuel.

- For propane, close the cylinder valve on the LPG cylinder.
- For natural gas, close the valve on the natural gas supply line.
- For gasoline, turn off the fuel switch.



Only Gasoline

6. After the generator has completely cooled down, remove propane(or methane) hose if applicable and store the generator in a cool, dry, sheltered storage area.

7. Remove or consume all untreated gasoline if you plan to store the generator longer than 3 months.

IMPORTANT NOTES

The above instructions for starting and stopping the generator are normal procedures. Users must follow standard procedures to start, use and shut down the generator.

1. If the user directly turns off the generator with the main switch, there may be a sound of muffler blasting, which is a normal phenomenon under abnormal operation.
2. When the battery is not connected or the battery is out of charge, if the user directly turns off the generator with the main switch, it may be difficult or impossible to start the cold machine, which is a normal phenomenon under abnormal operation.



USING THE GENERATOR

SERVICE ENVIRONMENT OF THE GENERATOR

- Applicable temperature: 23°F/-5°C ~ 104°F/40°C;
- Applicable humidity: below 95%;
- Applicable altitude: regions below 1,500 m (It shall be used by reducing power in regions above 1,000 m).

Standard atmospheric condition

- Ambient temperature T_r : 298k (77°F/25°C)
- Relative air humidity Φ_r : 30%
- Absolute atmospheric pressure P_r : 100kPa

When actual environmental condition is inconsistent with the condition of output power of the generator set:

- Every 5°C of increase in ambient temperature will reduce the power of generator by about 2%.
- Every 30% of increase in relative humidity of air will reduce the power of generator by about 1.5%.
- Every 300 m rising of ASL will reduce the power the generator by about 4.5%.

GENERATOR WIRING

- When the generator is connected to household power source as a backup power supply, the connection shall be carried out by a professional electrician or a person familiar with electricity.
- After connecting the load to the generator, check carefully whether electrical connection is safe and reliable. Improper electrical connection may cause generator damage, burning or fire.
- Avoid connecting this generator to commercial power outlet.
- When extending the cable, be sure not to exceed its length.

① 60m cross-section area is 1.5mm²

② 100m cross-section area is 2.5mm²

- The appearance of extension cable shall be protected by a layer of tough and elastic rubber cover (IEC25) or other substitutes.

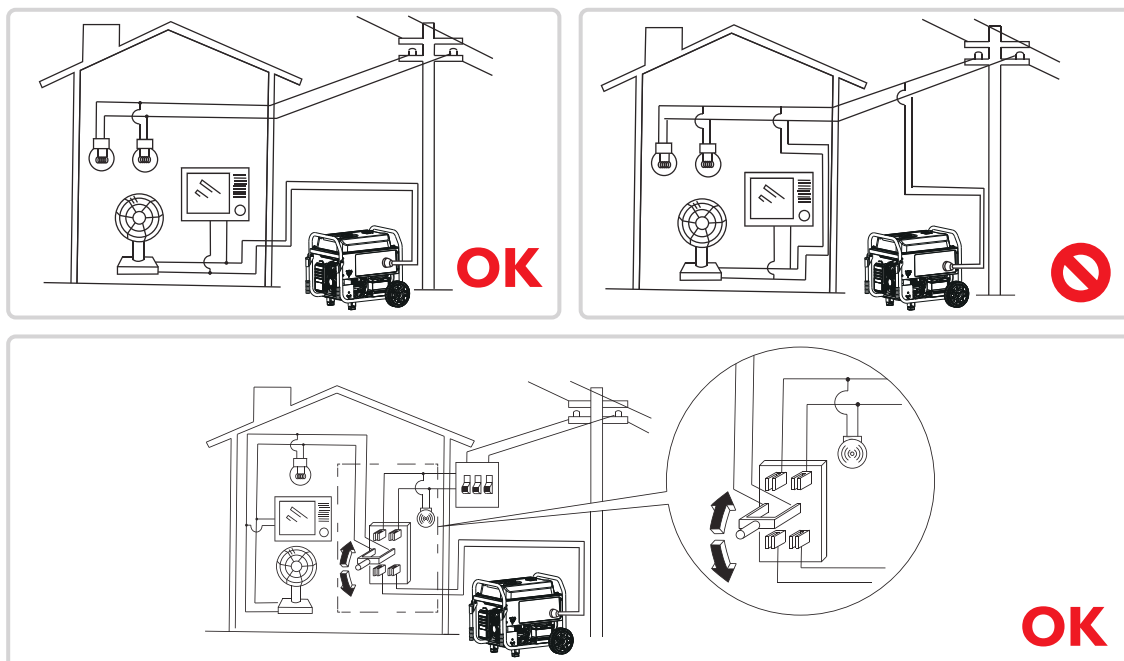

USING THE GENERATOR

Connection of AC power

WARNING

All electrical equipment shall be disconnected before inserting the plug.

ATTENTION

- Make sure that all electrical equipment, including wires and plugs, are in good condition before connecting to the generator;
- Make sure that all loads driven by the generator are within rated load range;
- Make sure that load current is within rated current range of rated socket.

Tip: Make sure that the generator set is grounded, and if electrical equipment requires grounding, the generator set must be grounded.

- ① Start up the engine;
- ② Turn energy-saving switch to "ON";
- ③ Insert the plug into AC outlet;
- ④ Make sure that AC indicator is lit up;
- ⑤ Switch on electrical equipment.

Tip: Before increasing engine speed, energy-saving switch must be switched to "OFF". If the generator set supplies power to multi loads or electrical equipment, start from large to small according to the size of each electrical equipment.

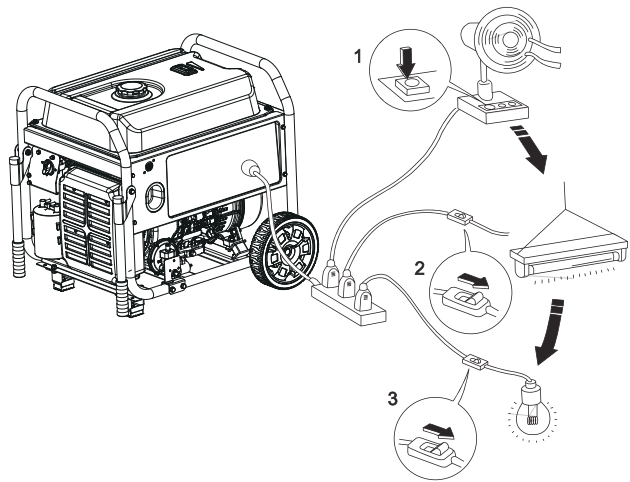

GENERATOR GROUNDING

In order to prevent any damage to the generator caused by electric shock or improper electrical application, it is recommended that the generator is grounded with good conductor with insulating sheath.

- ① Please use grounding wire with sufficient electrical energy capacity;
- ② Connect one end of grounding wire reliable to grounding bolt on control panel of the generator set;
- ③ Insert grounding body (iron rod with a diameter of 5 ~ 10mm) 200mm below into the earth and lead it out with conductor;
- ④ Connect the other end of the grounding wire reliable to the led wire of grounding body.



CHANGING THE NEUTRAL POINT

This generator is "neutral bonded" state, if you want to change to a "neutral floating" state, please refer to the website: <https://www.genmaxpower.com/page/faq>

USING THE GENERATOR

BATTERY CHARGING

The battery storage time is generally about 6 months. If the generator is not used for a long time, the battery will run out of power. At this time, the battery should be charged. Replace the battery if it is damaged or fails to charge.

Hand start charging: Start the generator by hand, and the battery will be charged automatically when the generator runs.

Use an external power source for charging:

Connect the battery charger to the battery charging port on the generator panel and connect the mains to charge the battery.
(Sell Separately)



Battery Charger



WARNING

Do not start the generator while charging with an external power supply. Keep batteries away from fire sources. Keep the battery in a cool and dry place, away from direct sunlight. Keep batteries away from children.

ATTENTION

1. Charge properly

Keeping battery properly charged and discharged can prolong battery life. Maintaining a power level of 10%-90% in battery is beneficial for battery protection.

2. Choose the appropriate charging temperature

Battery charging temperature range: 32-113°F/0-45°C.

3. Avoid overcharging

Overcharging of battery must be avoided during the charging process. Overcharging of battery in any form will lead to serious damage to battery performance and even explosion.

USING THE GENERATOR

CONNECTING AUTOMATIC START/STOP DEVICES

This generator can be controlled to start and stop through an external intelligent control system.

ATTENTION

When using other external intelligent control systems to control the generator, please carefully read the manual provided with the equipment.

AUTO GEN START

1. Select the fuel source according to the startup steps, connect the battery cable, and press the main switch to the "ON" position.
2. Turn the AUTO GEN START SWITCH to ON.

(One -key start, and remote control cannot control the start of the generator. Only the AUTO GEN START can control the generator.)



3. When the AUTO GEN START connected, the external intelligent control system controls the start and stop of the generator (it will start and run if the two wires are Short-circuited, and shut down if they are disconnected).

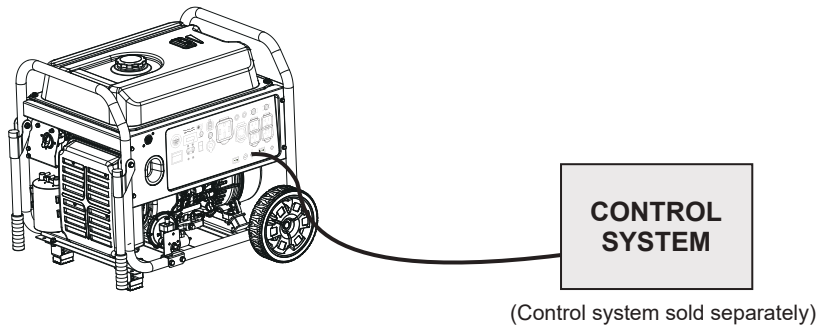

AUTO GEN STOP

1. Turn the AUTO GEN START SWITCH to OFF.

(one -key start, the remote control can control the start of the generator, AUTO GEN START can not control the generator.)



ATTENTION

- After this function is enabled, the push start button and remote start start/stop button and remote start are disabled.
- Before connecting automatic start/stop equipment, please carefully read the accompanying manual.

SERVICE AND MAINTENANCE

Good maintenance and service is the best guarantee for safe, economical and zero-failure operation. It also contributes to environmental protection.

In order to keep the generator in good condition, you must inspect and maintain it regularly. The maintenance schedule is as follows:

| Maintenance cycle | | Item | | | |
|--|-------------------------|--|------------------------------|---|---------------------------|
| | | Each | First in 1 month or 20 hours | Then every three months or every 50 hours | 100 hours per year or use |
| Engine oil | Check-fill | √ | | | |
| | Replace | | √ | √ | |
| Gearbox gear Oil (if any) | Check oil | √ | | | |
| | Replace | | √ | √ | |
| Air cleaner element | Inspection | √ | | | |
| | Clean | | √ | | |
| | Replace | | | √ | |
| Settling cup (if any) | Clean | | | | √ |
| Spark plug | Clean-adjust | | | | √* |
| Spark eliminator | Clean | | | √ | |
| Idle speed (if any)** | Check-adjust | | | | √ |
| Valve clearance** | Check-adjust | | | | √ |
| Fuel tank and fuel filter*** | Clean | | | | √ |
| Fuel line | Inspection | Every two years (Please replace if necessary) | | | |
| Cylinder head, piston | Remove carbon deposit** | Displacement < 225cc, every 125 hours; displacement capacity ≥ 225cc, every 250 hours. | | | |
| * These items shall be replaced if necessary; ** These items shall be maintained by the dealer authorized by the Company, unless the user has proper tools and maintenance ability. | | | | | |

ATTENTION

- If it often works under high temperature or high load, oil shall be changed every 25 hours;
- If it often works in dusty or harsh environment, air cleaner element shall be cleaned every 10 hours. If necessary, the air cleaner element shall be replaced every 25 hours;
- It shall be maintained on spot-inspection cycle and time, whichever is earlier;
- If maintenance cycle time has elapsed, perform the maintenance as soon as possible as per the table above.

SERVICE AND MAINTENANCE

WARNING

Please shut down the engine first before performing any maintenance. The engine shall be placed in a horizontal position. In order to prevent the engine from starting up, separate spark plug cap shall be separated from spark plug.

Do not use it indoors or use it in a tunnel, cave or other places ventilated poorly. Make sure that work area is well ventilated. Exhaust gas from the engine contains toxic gases, carbon oxides, and the inhalation can cause shock, loss of consciousness, and even death.

CHECKING AND FILLING FUEL

WARNING

TO PREVENT SERIOUS INJURY FROM FIRE:

Fill the fuel tank in a well-ventilated area away from ignition sources. If the engine is hot from use, shut the engine off and wait for it to cool before adding fuel. Do not smoke.

1. Clean the Fuel Cap and the area around it.
2. Unscrew and remove the Fuel Cap.
3. Remove the strainer and remove any dirt and debris. Then replace the strainer.

Note: Do not use gasoline containing more than 10% ethanol (E10). Do not use E85 ethanol.

Note: Do not use gasoline that has been stored in a metal fuel container or a dirty fuel container. It can cause particles to enter the carburetor, affecting engine performance and/or causing damage.

4. If needed, fill the Fuel Tank to about 1.5 inch under the fill neck with 87 octane unleaded gasoline that has been treated with a fuel stabilizer additive. Follow fuel stabilizer manufacturer's recommendations for use.
5. Replace the Fuel Cap.
6. Wipe up any spilled fuel and allow excess to evaporate before starting the engine. To prevent FIRE, do not start the engine while the smell of fuel hangs in the air.

CLEANING THE GENERATOR

Do not store or operate your generator in dirty, dusty, or corrosive environments. Do not allow foreign materials and debris to clog the vents on the unit.

NEVER clean the generator with a garden hose. Water can damage the generator's fuel system and electrical components. If the unit needs to be cleaned, use a soft brush and damp cloth to clean the exterior and use low pressure air (no greater than 25 psi) to clean the vents.

Never use gasoline as a cleaning agent.

SPARK PLUG INSPECTION

The spark plug is important for proper engine operation. A good spark plug should be intact, free of deposits, and properly gapped.

Improper maintenance may cause reduced fuel economy, misfires, trouble starting, or damage to the spark plug threads.

WARNING

Turn off the generator and wait for the generator to completely cool down.

1. Pull out the spark plug cap.



SERVICE AND MAINTENANCE

2. Unscrew the spark plug from the generator using the spark plug wrench included with this product.



3. Inspect the Spark Plug.

If the electrode is oily, clean it using a clean, dry rag. If the electrode has deposits on it, clean it with a brass wire brush. If the white insulator is cracked or chipped, replace the spark plug.



4. Check the model of spark plug and clearance.

Spark plug gap: 0.7-0.8mm

Standard spark:

| BRAND | MODEL |
|----------|--------|
| NGK | BPR6ES |
| TORCH | F6RTC |
| CHAMPION | RN11YC |
| BOSCH | WR6DS |



5. Reinstall the spark plug.

Spark plug torque: 22.5±2.5N.m(199±22in-lb)

Tip: If there is no torque wrench when installing the spark plug, a better estimation method is to screw it 1/4-1/2 turns by force after screwing it in place, but the spark plug shall be screwed to specified torque as soon as possible.



6. Replace Spark Plug Cap.



ENGINE OIL CHANGE

WARNING

Do not drain the oil immediately after turning off the generator. Oil temperature is very high, when operating, take care to avoid scalding.

NOTE: Change the oil while the engine is warm but not hot. Warm engine oil drains more quickly and thoroughly than cool lubricant. Contact with hot lubricant will cause serious burns.

SERVICE AND MAINTENANCE

1. Drain engine oil. The oil drain bolt is located below the cylinder head.

Place an oil pan (or suitable container) under the oil drain bolt, remove the oil drain bolt and allow the oil to drain.

Drain oil into an approved oil disposal container. Contact your local auto parts store for information on oil disposal.



2. After the oil has drained completely, replace the oil drain bolt.

Follow the procedure of "Adding Engine Oil" to add new engine oil and check the oil level.



3. Clean up any spilled oil.

OIL FILTER

It is recommended to clean the oil filter after the first operation of the generator. After that, it will be cleaned every 50 hours.

1. Drain the oil from the engine as in the previous oil drain change procedure, and then remove the oil filter next to it;

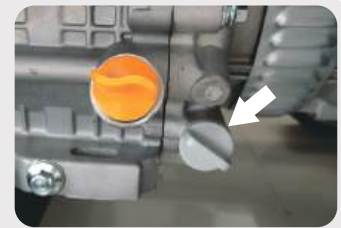

2. Clean the impurities inside the filter plug. If the impurities are too much to clean, use detergent to clean;

3. After cleaning, blow dry with compressed air or air dry naturally and put back in the original position.



CLEANING/REPLACING THE AIR FILTER

Dirty air cleaner may prevent air from flowing into the carburetor. In order to prevent failure of the carburetor, please maintain air cleaner regularly. If being used in a dusty environment, it shall be maintained frequently.

1. Turn off the generator and let the engine cool down.

2. Remove screws, to remove cover plate of air cleaner.



SERVICE AND MAINTENANCE

2. Remove the air filter element.



3. Clean the components with cleaning agent. After cleaning, wrap the components in a cloth and screw them dry.

NOTE: If the air filter element is damaged, replace it with a new one.



4. Drip a few drops of oil to foam filter element and squeeze off excess oil. The foam cleaner element shall be wet, but there shall not be oil dripping.

NOTE: Be sure not to twist the foam cleaner element forcibly to avoid damage.



5. Return the air filter element to its original position. Reinstall the air filter cover.

NOTE: Make sure that the surface of foam cleaner element is in close contact with air cleaner, and there shall be no gap leaking air. Be sure not to start the engine before air cleaner is assembled, because it will generate excessive toxic gas and wear the cylinder.



CLEAN THE FUEL FILTER

WARNING

Be sure not to open fuel tank of the generator in a place where smoking or with flame.

1. Remove fuel tank cap and fuel tank filter screen.
2. Clean fuel tank filter screen with gasoline.
3. Wipe filter screen dry, and put it back into fuel tank.
4. Reassemble fuel tank cap.



STORAGE AND TRANSPORT

GENERATOR STORAGE

If it is stored long-term, in order to prevent aging, you shall take some storage measures.

1. Turn off the generator and let it cool completely.
2. Open fuel tank cap, to take out fuel filter screen. Pump all fuel in fuel tank into special fuel tank, and then reassemble fuel tank cap back.
3. Start up the engine to burn off fuel in the carburetor, and then shut it down.

NOTE: Do not connect any electrical equipment. Running time of the engine depends on remaining fuel in the fuel tank.

4. Unscrew fuel drain bolt on the carburetor, and drain fuel in the carburetor into special fuel tank. Tighten fuel drain bolt.
5. Unscrew oil dipstick, and drain oil in the crankcase off. Fill new oil to upper oil limit, and then assemble oil dipstick.
6. Remove the spark plug and pour 5-10ml of clean oil into the combustion chamber. Turn the crankshaft a few times to distribute the oil, then reassemble the spark plug.



7. Disconnect the battery cable.
8. Gently pull startup handle until you feel resistance, allowing both inlet valve and exhaust valve to be closed.



9. Clean the generator.

NOTE: Please do not rinse the generator with water. There is a possibility of causing malfunctions and short circuits in electrical components.

10. Place the generator set in a clean and dry area.

ATTENTION

Placing the Generator

- After the generator cools down, place it upright and cover it with a layer of dust cloth. The generator should be placed in a well ventilated and dry place.
- Do not pile up debris on the generator.

GENERATOR TRANSPORT

- When the generator set is transported, it shall be ensured that there is no fuel spilling.
- Do not fill excessive fuel into fuel tank.
- Do not run the generator, and avoid direct sunlight.
- Do not transport the generator set on rough road for long time.

PREPARATION FOR USE AFTER STORAGE

- Slowly pull the starter cord a few times to clean oil from the cylinder or to eject any pump protector from the pump which may have been added prior to storage.
- Remove the spark plug from the cylinder. Wipe oil from the spark plug and return it to the cylinder and re-tighten.
- Reconnect the spark plug wire.
- Refuel engine per earlier instructions in this manual.

TROUBLESHOOTING

| Problem | Possible Causes | Probable Solutions |
|-----------------------|--|--|
| Engine will not start | FUEL RELATED: <ol style="list-style-type: none"> No fuel in tank or fuel valve closed. Choke not in START position, cold engine. Gasoline with more than 10% ethanol used. (E15, E20, E85, etc.) Low quality or deteriorated, old gasoline. Carburetor not primed. Dirty fuel passageways. Carburetor needle stuck. Fuel can be smelled in the air. Too much fuel in chamber. This can be caused by the carburetor needle sticking. Clogged Fuel Filter. | FUEL RELATED: <ol style="list-style-type: none"> Fill fuel tank with fresh 87+ octane stabilizer-treated unleaded gasoline and open fuel valve. Do not use gasoline with more than 10% ethanol (E15, E20, E85, etc.). Move Choke to START position. Clean out ethanol rich gasoline from fuel system. Replace components damaged by ethanol. Use fresh 87+ octane stabilizer-treated unleaded gasoline only. Do not use gasoline with more than 10% ethanol (E15, E20, E85, etc.). Use fresh 87+ octane stabilizer-treated unleaded gasoline. Do not use gasoline with more than 10% ethanol (E15, E20, E85, etc.). Pull on Starter Handle to prime. Clean out passageways using fuel additive. Heavy deposits may require further cleaning. Gently tap side of carburetor float chamber with screwdriver handle. Turn Choke to RUN position. Remove spark plug and pull the start handle several times to air out the chamber. Reinstall spark plug and set Choke to START position. Replace Fuel Filter. |
| | IGNITION (SPARK) RELATED: <ol style="list-style-type: none"> Power Switch at OFF position. Spark plug cap not connected securely. Spark plug electrode wet or dirty. Incorrect spark plug gap. Spark plug cap broken. Circuit breaker tripped (electric start models only). Incorrect spark timing or faulty ignition system. | IGNITION (SPARK) RELATED: <ol style="list-style-type: none"> Turn Power Switch to ON. Connect spark plug cap properly. Clean spark plug. Correct spark plug gap. Replace spark plug cap. Reset circuit breaker. Check wiring and starter motor if breaker continues to trip. Have qualified technician diagnose/repair ignition system. |
| | COMPRESSION RELATED: <ol style="list-style-type: none"> Cylinder not lubricated. Problem after long storage periods. Loose or broken spark plug. (Hissing noise will occur when trying to start.) Loose cylinder head or damaged head gasket. (Hissing noise will occur when trying to start.) Engine valves or tappets mis-adjusted or stuck. | COMPRESSION RELATED: <ol style="list-style-type: none"> Pour tablespoon of oil into spark plug hole. Crank engine a few times and try to start again. Tighten spark plug. If that does not work, replace spark plug. If problem persists, may have head gasket problem, see #3. Tighten head. If that does not remedy problem, replace head gasket. Have qualified technician adjust/repair valves and tappets. |
| | ENGINE OIL RELATED: <ol style="list-style-type: none"> Low engine oil. Engine mounted on slope, triggering low oil shutdown. | ENGINE OIL RELATED: <ol style="list-style-type: none"> Fill engine oil to proper level. Check engine oil before EVERY use. Operate engine on level surface. Check engine oil level. |
| | SPARK ARRESTOR RELATED: <ol style="list-style-type: none"> Spark Arrestor clogged with soot. | SPARK ARRESTOR RELATED: <ol style="list-style-type: none"> Clean and replace Spark Arrestor. |



Follow all safety precautions whenever diagnosing or servicing the generator or engine.

TROUBLESHOOTING

| Problem | Possible Causes | Probable Solutions |
|--|---|---|
| Engine misfires | <ol style="list-style-type: none"> 1. Spark plug cap loose. 2. Incorrect spark plug gap or damaged spark plug. 3. Defective spark plug cap. 4. Old or low quality gasoline. 5. Incorrect compression. | <ol style="list-style-type: none"> 1. Check cap and wire connections. 2. Re-gap or replace spark plug. 3. Replace spark plug cap. 4. Use only fresh 87+ octane stabilizer-treated unleaded gasoline. Do not use gasoline with more than 10% ethanol (E15, E20, E85, etc.). 5. Diagnose and repair compression. (Use Engine will not start: COMPRESSION RELATED section.) |
| Engine stops suddenly | <ol style="list-style-type: none"> 1. Carbon Monoxide level high. Red light on Carbon Monoxide Sensor illuminates. 2. CO Sensor Alarm flashes yellow continually shortly after starting. 3. CO Sensor Alarm flashes yellow continually after longer period of operation. 4. Low oil shutdown. 5. Fuel tank empty or full of impure or low quality gasoline. 6. Defective fuel tank cap creating vacuum, preventing proper fuel flow. 7. Faulty magneto. 8. Disconnected or improperly connected spark plug cap. | <ol style="list-style-type: none"> 1. Leave area immediately and allow area to ventilate thoroughly. Only operate generator outside. 2. Carbon monoxide sensor malfunction. Sensor needs service. Do not use the Generator until the sensor is working properly. 3. Make sure to operate generator within rated ambient temperature; maintain minimum 5 ft. clearance from all sides. 4. Fill engine oil to proper level. Check engine oil before EVERY use. 5. Fill fuel tank with fresh 87+ octane stabilizer treated unleaded gasoline. Do not use gasoline with more than 10% ethanol (E15, E20, E85, etc.). 6. Test/replace fuel tank cap. 7. Have qualified technician service magneto. 8. Secure spark plug cap. |
| Engine stops when under heavy load | <ol style="list-style-type: none"> 1. Dirty air filter 2. Engine running cold. | <ol style="list-style-type: none"> 1. Clean element. 2. Allow engine to warm up prior to operating equipment. |
| Engine knocks | <ol style="list-style-type: none"> 1. Old or low quality gasoline. 2. Engine overloaded. 3. Incorrect spark timing, deposit buildup, worn engine, or other mechanical problems. | <ol style="list-style-type: none"> 1. Fill fuel tank with fresh 87+ octane stabilizer-treated unleaded gasoline. Do not use gasoline with more than 10% ethanol (E15, E20, E85, etc.). 2. Do not exceed equipment's load rating. 3. Have qualified technician diagnose and service engine. |
| Engine backfires | <ol style="list-style-type: none"> 1. Impure or low quality gasoline. 2. Engine too cold. 3. Intake valve stuck or overheated engine. 4. Incorrect timing. | <ol style="list-style-type: none"> 1. Fill fuel tank with fresh 87+ octane stabilizer-treated unleaded gasoline. Do not use gasoline with more than 10% ethanol (E15, E20, E85, etc.). 2. Use cold weather fuel and oil additives to prevent backfiring. 3. Have qualified technician diagnose and service engine. 4. Check engine timing. |
| Attached device doesn't have power | <ol style="list-style-type: none"> 1. Device not plugged in properly. 2. Circuit Breaker tripped. 3. Product needs service. | <ol style="list-style-type: none"> 1. Turn off and unplug the device, then plug it back in again and turn on. 2. Turn off and unplug device, reset Circuit Breaker, plug in device and turn on. 3. Have product repaired. |
| Attached device begins to operate abnormally | <ol style="list-style-type: none"> 1. Problem with device. 2. Rated load capacity exceeded. | <ol style="list-style-type: none"> 1. Immediately unplug device. Have device repaired by a qualified technician, or replace device. 2. Lower the number of items plugged into the generator to stay within the rated capacity, or use a more powerful generator. |



Follow all safety precautions whenever diagnosing or servicing the generator or engine.

TECHNICAL PARAMETERS

| Item | GM12000XiT |
|--|--|
| Rated Power (kW) | 10.0(GAS.)/9.0(LPG)/8.0(NG) |
| Max. Power (kW) | 12(GAS.)/10.8(LPG)/9.6(NG) |
| Engine Model | 192F/P-2 |
| Valve Clearance | Input valve:0.010~0.15 mm, Output valve:0.15~0.20 mm |
| Stroke × Bore (mm) | 92×69 |
| Engine Type | 4-stroke |
| Displacement (cc) | 458 |
| Gas Distribution Mode | OHV |
| Cooling Mode | Forced cooling wind |
| Rated Speed (RPM) | 3800 |
| Starting Method | Recoil Start / Electrical Start / Remote start |
| Fuel Tank Volume (gal) | 10.6(40L) |
| Fuel Type | Gas / LPG / NG |
| LPG Tank Capacity (Suggest) | 20 Pound |
| Lubricating Oil Capacity (gal) | 0.3(1.1L) |
| Lubricating Oil Model | SAE 10W/30 |
| Noise dB (at 7m)(25% load) | 73 |
| Rated Voltage (V) | 120/240 |
| Rated Frequency (Hz) | 60 |
| Rated Power Factor | 1 |
| Phase Number | Single phase |
| Run Time @ 25% (h)(GAS.) | 16.6 |
| Fuel Consumption Rate (25% load)(L/h) | 2.4 |
| Fuel Consumption Rate (100% load)(L/h) | 5.85 |
| LPG Consumption Rate (25% load)(kg/h) | 1.47 |
| LPG Consumption Rate (100% load)(kg/h) | 3.5 |
| THD | ≤3% |
| Overall Dimension (in.) | 30×27.4×27.7(763×695×703mm) |
| Net Weight (lb.) | 194(88kg) |

QUICK REFERENCE WATTAGE

| Power Rating | Tool or Appliance | Running Watts | Starting Watts | | |
|------------------------------------|----------------------------------|----------------------------------|---------------------|------|------|
| 5500 - 12,000 Running Watts | 2800 - 3800 Running Watts | 1200 - 1800 Running Watts | Blender | 300 | 650 |
| | | | Coffee Maker | 1500 | |
| | | | Drill | 600 | 900 |
| | | | Fan | 200 | |
| | | | Furnace 1/4 hp | 600 | 1000 |
| | | | Game console | 150 | |
| | | | Hand sander | 600 | 1200 |
| | | | Hedge trimmer | 450 | 1200 |
| | | | Lamp | 100 | |
| | | | Laptop | 800 | |
| | | | LED/LCD TV | 150 | |
| | | | Microwave | 1000 | |
| | | | Modem/router | 20 | |
| | | | Paint sprayer | 600 | 600 |
| | | | Radio | 100 | |
| | | | Slow cooker | 200 | 200 |
| | | | String trimmer | 350 | 875 |
| | | | Sump Pump 1/3 hp | 800 | 1300 |
| Work light | 1000 | | | | |
| 5500 - 12,000 Running Watts | 2800 - 3800 Running Watts | 1200 - 1800 Running Watts | Belt sander | 1200 | 2400 |
| | | | Chainsaw | 1200 | 2400 |
| | | | Circular saw | 1200 | 2000 |
| | | | Edger | 950 | 2400 |
| | | | Electric grill | 1650 | |
| | | | Lawn mower | 1200 | 2400 |
| | | | Pressure washer | 1200 | 2400 |
| | | | Refrigerator | 700 | 2200 |
| | | | Washing machine | 1150 | 2250 |
| | | | Well pump | 1000 | 2100 |
| | | | Window AC 13k BTU | 1800 | 2800 |
| | | | Air compressor 1 hp | 1600 | 4500 |
| | | | Central AC 3 ton | 5400 | 7200 |
| | | | Electric Dryer | 5400 | 6750 |
| | | | Heat Pump 3 ton | 3400 | 6500 |
| | | | Water heater | 4000 | |

†Chart for reference only. Check your device for ACTUAL wattage requirements.

HOW TO CALCULATE

Running Watts needed:

Total Running Watts of ALL items to be powered by the generator.

Starting Watts needed:

Add highest SINGLE Starting Watt to Total Running Watts needed above.

EXAMPLE

1 Calculate Running Watts:

| | |
|----------------------------|-------------|
| Furnace | 600 |
| Lamp | 100 |
| Microwave | 1000 |
| Refrigerator | 700 |
| Total Running Watts | 2400 |

2 Calculate Starting Watts:

| | |
|-----------------------------|-------------|
| Total Running Wattage | 2400 |
| Refrigerator | 2200 |
| Total Starting Watts | 4600 |





In production management, based on orderly, efficient, scientific principles. trying to do as better as possible in product design, development, production, inspection, etc. to make our production can keep orderly. And will continue to make improvement to make sure that keep the competitiveness.

Welcome friends at home and abroad to visit and guide, work together to create brilliant.

GENMAX[®]

ADD: 301 Doubleday Ave Ontario CA 91761

Phone 866-960-2920

E-mail service@genmaxpower.com

Http://www.genmaxpower.com



Facebook



LinkedIn



YouTube

