

INVERTER GENERATOR USER'S MANUAL



GM9000iE

Portable Inverter Generator

7600 Running Watts | 9000 Peak Watts

GM9000iED/GM9000iEDC

Portable Inverter Generator

7600(GAS.)/7200(LPG) Running Watts | 9000(GAS.)/8550(LPG) Peak Watts



WARNING: SAVE THIS MANUAL FOR FUTURE REFERENCE



This manual contains important information regarding safety. Operation, maintenance and storage of this product. Before use, read carefully and understand all cautions, warnings, instructions and product labels. Failure to do so could result in serious personal injury and/or property damage.

**California
Proposition 65 Warning**

The engine exhaust from this product contains chemicals known to the state of California to cause cancer, birth defects or other reproductive harm.

**California
Proposition 65 Warning**

Certain components in this product and its related accessories contain chemicals known to the state of California to cause cancer, birth defects or other reproductive harm. Wash hands after handling.

DISCLAIMERS:

All information, illustrations and specifications in this manual are based on the latest information available at the time of publishing. The illustrations used in this manual are intended as representative reference views only. Moreover, because of our continuous product improvement policy, we may modify information, illustrations and/or specifications to explain and/or exemplify a product, service or maintenance improvement. We reserve the right to make any change at any time without notice. Some images may vary depending upon which model is shown.

ALL RIGHTS RESERVED:

No part of this publication may be reproduced or used in any form by any means - graphic, electronic or mechanical, including photocopying, recording, taping or information storage and retrieval systems - without the written permission of CHONGQING DINKING POWER MACHINERY CO., LTD

⚠ DANGER



This manual contains important instructions for operating this inverter generator. For your safety and the safety of others, be sure to read this manual thoroughly before operating the generator. Failure to properly follow all instructions and precautions can cause you and others to be seriously hurt or killed.

UNPACKING

⚠ CAUTION



Always have assistance when lifting the generator. The generator is heavy; lifting it could cause bodily harm.



Avoid cutting on or near staples to prevent personal injury.

WHAT COMES IN THE BOX

- Spark Plug Socket Wrench (1)
- Dual-Purpose Screwdriver (1)
- Owner Manual (1)
- Warranty Information (1)
- Funnel (1)
- NEMA 14-50P Industrial Plug (1)
- NEMA L14-30P Locking Plug (1)
- Remote Control Key (1)
- LPG Hose (GM9000iED/GM9000iEDC only)(1)
- 1100ml 10W30 Oil (1)

Tools required - box cutter or similar device.

- Carefully cut the packing tape on top of the carton.
- Remove socket wrench, and oil funnel and save for later.
- Carefully cut two sides of the carton to remove the generator.

DESCRIPTION OF FITTINGS

Spark Plug Socket Wrench



Used in spark plug maintenance, inspection, and installation.

Dual-Purpose Screwdriver



Phillips and slot blade screwdriver used for generator maintenance.

Funnel



It's used to oil the generator.

NEMA L14-30P Locking Plug



Plug heads for the receptacles found on the generator are included to make or rewire your own cords.

NEMA 14-50P Industrial Plug



Plug heads for the receptacles found on the generator are included to make or rewire your own cords.

Remote Control Key



Used to remotely start and stop the generator.

1100ml 10W30 Oil



Be sure to add oil before starting the generator.

LPG Hose

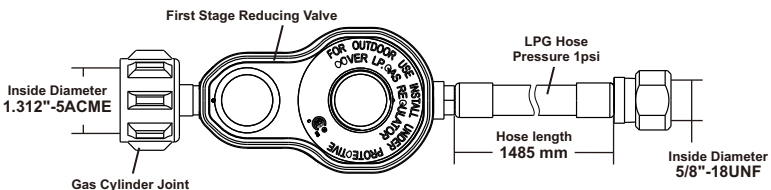
Connect the LPG tank to transmit LPG fuel to the generator.

LIMITED WARRANTY

1. DURATION : One (1) year from the date of purchase by the original purchaser (retail customer) on products used solely for consumer applications; if a product is used for business, commercial, or industrial applications, the warranty period will be limited to ninety (90) days from the date of purchase.
2. WHO GIVES THIS WARRANTY (WARRANTOR):
CHONGQING DINKING POWER MACHINERY CO., LTD
3. WHO RECEIVES THIS WARRANTY(PURCHASER):The original purchaser (other than for purposes of resale) of the Genmax's inverter.
4. WHAT PRODUCTS ARE COVERED BY THIS WARRANTY: Any portable generator supplied or manufactured by Warrantor.
5. WHAT IS COVERED UNDER THIS WARRANTY: Substantial defects on material and workmanship which occur within the duration of the warranty period.
6. WHAT IS NOT COVERED UNDER THIS WARRANTY:
 - A. Transportation charges for sending the product to Warrantor or its authorized service representative for warranty service, or for shipping repaired or replacement products back to the customer; these charges must be borne by the customer.
 - B. Damages caused by abuse, accident, shipping, misuse, overloading, modification, and the effects of corrosion, erosion and normal wear and tear.
 - C. Warranty is voided if the customer fails to install, maintain and operate the product in accordance with the instructions and recommendations set forth in the owner's manual(s), or if the product is used as rental equipment.
 - D. Pre-delivery service, i.e. assembly, oil or lubricants, and adjustment.
 - E. Items or service that are normally required to maintain the product, i.e. lubricants and filters.
 - F. Warrantor will not pay for repairs or adjustments to the product, or for any costs or labour, performed without Warrantor's prior authorization.

EXCLUSIONS AND LIMITATIONS : Warrantor makes no other warranty of any kind, express or implied. Implied warranties, including warranties of merchantability and of fitness for a particular purpose, are hereby disclaimed. This warranty service described above is the exclusive remedy under this warranty; liability for incidental and consequential damages is excluded to the extent permitted by law.

7. RESPONSIBILITIES OF PURCHASER UNDER THIS WARRANTY:
 - A. The purchaser must provide dated proof of purchase and must notify Warrantor within the warranty period.
 - B. Deliver or ship the serviced generator or component to the nearest Warrantor's authorized service representative. Freight costs, if any, must be borne by the purchaser.

8. HAVE QUESTIONS?
Email: service@genmaxpower.com Phone: 866-960-2920

WARRANTY CARD

PERSONAL INFORMATION

Name: _____
Street Address: _____
City, State, ZIP: _____
Country: _____
Phone Number: _____
E-Mail: _____

INVERTER INFORMATION

Model Number: _____
Serial Number: _____
Date Purchased: _____
Purchased From: _____



TABLE OF CONTENTS

LIMITED WARRANTY	3
SAFETY WARNING	5
SAFETY INSTRUCTIONS	6
NAMES OF COMPONENTS	8
CONTROL FUNCTIONS	9
PREPARATIONS	14
1.Fuel.....	14
2.Oil.....	14
3.Pre-operation Inspection.....	15
STARTING UP THE GENERATOR	16
SHUTTING DOWN THE GENERATOR	21
USING THE GENERATOR	22
1.Service Environment of the Generator.....	22
2.Generator Wiring.....	22
3.Generator Grounding.....	23
4.Changing the Neutral Point.....	24
5.Battery Charging.....	24
SERVICE AND MAINTENANCE	25
1.Spark Plug Inspection.....	26
2.Adjustment of the Carburetor.....	27
3.Replacement of Oil.....	27
4.Oil Filter.....	28
5.Air Filter.....	28
6.Fuel Filter Screen.....	29
STORAGE AND TRANSPORT	30
1.Generator Storage.....	30
2.Generator Transport.....	31
TROUBLESHOOTING	32
TECHNICAL PARAMETERS	34
CHOOSING A GENERATOR	35

SAFETY WARNING



Personal and property safeties of you and others are very vital. Please read the Safety Warning in the User's Manual and the decals of the generator set carefully. The Safety Warning can alert you to those potential hazards that could harm you and others. In front of each Safety Warning, there is one of four words "**DANGER**" "**WARNING**", "**ATTENTION**", and "**CAREFUL**". Details are as follows:

DANGER

Failure to follow the instruction will result in being in peril of your life or extremely serious injury.

WARNING

Failure to follow the instruction will result in being in peril of your life or very serious injury.

CAREFUL

Failure to follow the instruction will result in minor injury.

ATTENTION

Failure to follow the instruction will result in the damage to your generator set and other properties.

CO TECHNICAL WARNING

CO DETECT technology monitors the accumulation of carbon monoxide (CO), a poisonous gas produced by engine exhaust when the generator is running. If CO Sensor detects unsafe elevated levels of CO gas, it automatically shuts off the engine. CO Sensor is not a substitute for an indoor carbon monoxide alarm or for safe operation. DO NOT allow engine exhaust fumes to enter a confined area through windows, doors, vents or other openings. Generators must ALWAYS be used outdoors, far away from occupied buildings with engine exhaust pointed away from people and buildings. Meets the requirements of ANSI/PGMA G300-2018.

NEUTRAL FLOATING

For portable generators where the neutral is floating, the operator's manual shall include the following wording or equivalent:

The portable generator stator winding is isolated from the frame and from the AC receptacle ground pin; and Electrical devices that require a connection between one conductor pin and the grounded receptacle pin may not function properly.

SAFETY INSTRUCTIONS

Before operating the generator, it will help you avoid accidents to read and understand the Manual and familiarize yourself with the safe operation procedures of the generator.

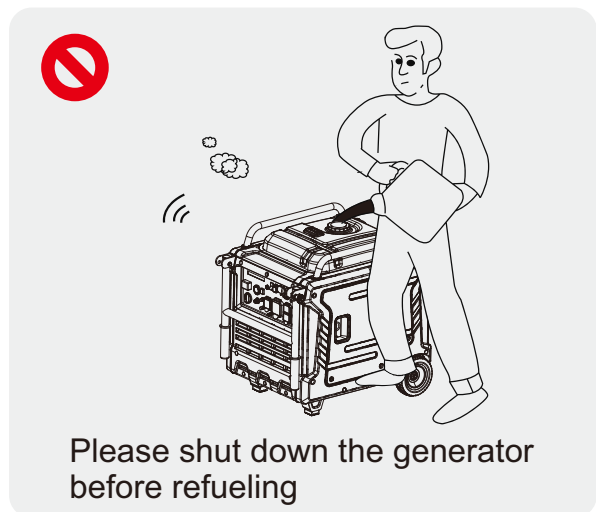

SAFETY INSTRUCTIONS

SAFETY LABELS AND DECALS

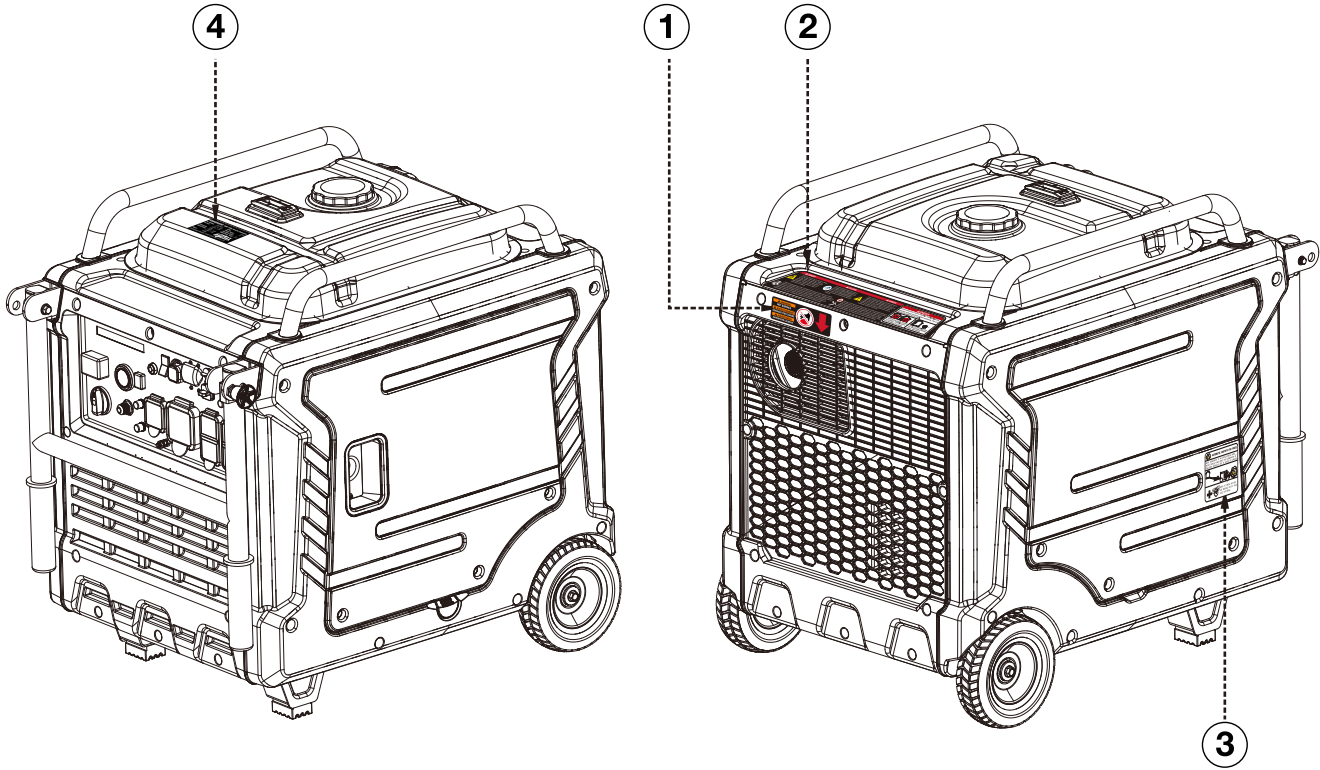

1

⚠ WARNING
HOT SURFACE
⚠ AVERTISSEMENT
SURFACES TRÈS CHAUDES
⚠ ADVERTENCIA
SUPERFICIES CALIENTE

2

⚠ DANGER Risk of fire. Check for any fuel overflow or leakage. Do not touch engine exhaust assembly. **⚠ PELIGRO** You could be killed or seriously hurt if you do not follow the Generator's manual instructions. **⚠ DANGER** Failure to properly ground generator can result in electrocution. **⚠ DANGER** Using a generator indoors CAN KILL YOU IN MINUTES. Generator exhaust contains carbon monoxide. This is a poison you cannot see or smell.

NEVER use inside a home or garage, EVEN IF doors and windows are open. **Only use OUTSIDE and far away from windows, doors, and vents.**

3

GM9000iE Inverter Generator

AC Voltage: 120/240V	RPM: 3400
Current: 63.3/31.7A	Power Factor: 1.0
Frequency: 60Hz	Insulation Class: F
Rated Power: 7.6kW	Rated Amb. Temp.: 25°C
Phase: Single	
DC Output: 5V 1A/2.1A	

GENMAX
 CHONGQING DINKING POWER MACHINERY CO.,LTD.

4

⚠ AUTOMATIC SHUTOFF-YOU MUST:

MOVE GENERATOR TO AN OPEN, OUTDOOR AREA. POINT EXHAUST AWAY. DONT RUN GENERATOR IN ENCLOSED AREAS (E.G. NOT IN HOUSE OR GARAGE).

+ MOVE TO FRESH AIR AND GET MEDICAL HELP IF SICK, DIZZY OR WEAK.

NAMES OF COMPONENTS



① **Fuel Tank Cap:** Open the fuel tank cap and fill with proper amount of gasoline.

② **Recoil Handle:** Pull to start the engine.

③ **Fuel Tank:** Store the added gasoline.

④ **Left Outer Cover:** Unscrew the bolt, remove the outer cover, connect the battery wire, maintain the air filter and replace the spark plug.

⑤ **Control Panel:** Contains the reset breaker, outlets and warning lights.

⑥ **Engine Cooling Vents:** Helps move airflow in unit to regulate engine temperatures.

⑦ **Right Outer Cover:** Unscrew the bolts, remove the outer cover, and add or change the oil.

⑧ **Muffler:** Avoid contact until the engine is cooled down. The spark arrestor prevents sparks from exiting the muffler. It must be removed for servicing.

⑨ **Wheel**

⑩ **Handrail**

CONTROL FUNCTIONS

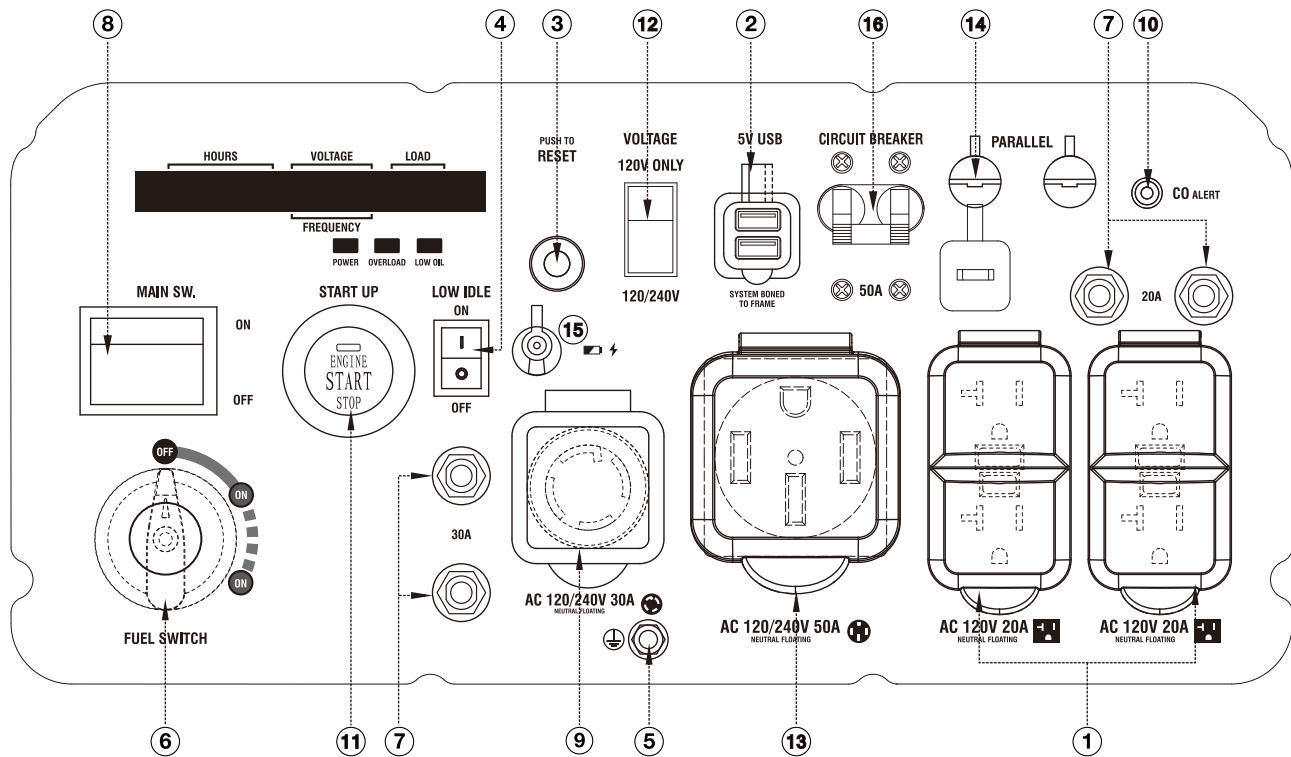

CONTROL PANEL FEATURES GM9000iE

- ① **120V AC 20A 5-20R Outlet:** The outlet is capable of carrying a maximum of 20 amps.
- ② **USB Duplex:** 5V DC that come in 1 amps and 2.1 amps.
- ③ **Reset:** If the inverter is overloaded, the reset breaker will trip. The engine will continue to run, but there will be no output from the inverter. Unplug the devices and reduce the load. Push in the reset breaker to reset it.
- ④ **Low Idle:** When turned to the ON position, the engine will sense the load needed and run at a slower RPM to save fuel.
- ⑤ **Ground Terminal:** The ground terminal is used to externally ground the inverter.
- ⑥ **Fuel Switch:** Open the fuel.
- ⑦ **AC Breaker:** If the inverter is overloaded, the reset breaker will trip to block current.
- ⑧ **Main Switch:** Manage battery power and shutdown.
- ⑨ **120/240V AC 30A L14-30R Outlet:** The outlet is capable of carrying a maximum of 30 amps.
- ⑩ **CO Alarm:** Shuts down the engine in the event of CO buildup.
- ⑪ **One Push Start:** Press this button, the engine can start and stop.
- ⑫ **Voltage Switch:** Switch between 120V and 240V voltage as required.
- ⑬ **120/240V AC 50A 14-50R Outlet:** Receptacle can supply a maximum of 50 Amps.
- ⑭ **Parallel Connectors:** To increase AC power output, the connector sockets are used to connect the two same type generators with special parallel cable GM9000PK sold by GENMAX. The connector sockets is only used to connect two inverter generators. They can not used for AC power output. The special parallel cable GM9000PK shall be purchased separately, and they shall be approved by certification body.
- ⑮ **Battery Charging Port:** Charge the generator battery.
- ⑯ **Circuit Breaker:** A circuit breaker interrupts the current when the whole circuit is overloaded.

CONTROL FUNCTIONS

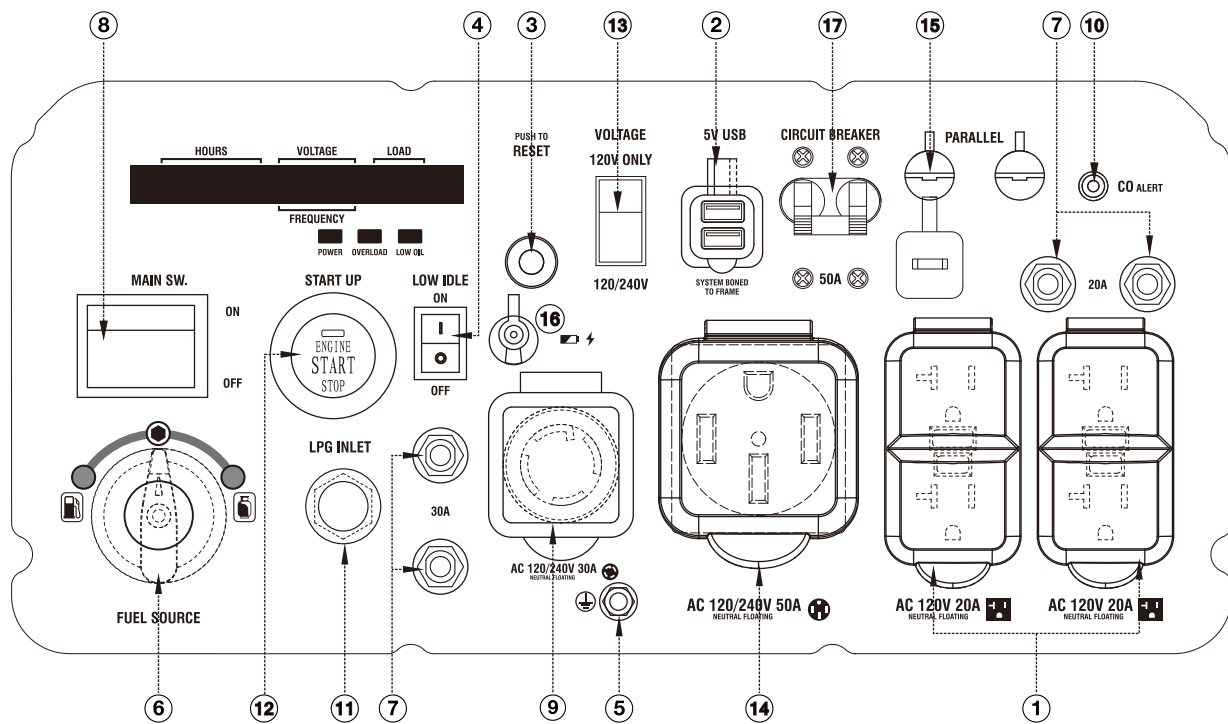

CONTROL PANEL FEATURES GM9000iED/GM9000iEDC

- ① **120V AC 20A 5-20R Outlet:** The outlet is capable of carrying a maximum of 20 amps.
- ② **USB Duplex:** 5V DC that come in 1 amps and 2.1 amps.
- ③ **Reset:** If the inverter is overloaded, the reset breaker will trip. The engine will continue to run, but there will be no output from the inverter. Unplug the devices and reduce the load. Push in the reset breaker to reset it.
- ④ **Low Idle:** When turned to the ON position, the engine will sense the load needed and run at a slower RPM to save fuel.
- ⑤ **Ground Terminal:** The ground terminal is used to externally ground the inverter.
- ⑥ **Fuel Switch:** Open the fuel.
- ⑦ **AC Breaker:** If the inverter is overloaded, the reset breaker will trip to block current.
- ⑧ **Main Switch:** Manage battery power and shutdown.
- ⑨ **120/240V AC 30A L14-30R Outlet:** The outlet is capable of carrying a maximum of 30 amps.
- ⑩ **CO Alarm:** Shuts down the engine in the event of CO buildup.
- ⑪ **LPG Inlet:** Connects the LPG inlet to the LPG hose/regulator.
- ⑫ **One Push Start:** Press this button, the engine can start and stop.
- ⑬ **Voltage Selector:** Switch between 120V and 240V voltage as required.
- ⑭ **120/240V AC 50A 14-50R Outlet:** Receptacle can supply a maximum of 50 Amps.
- ⑮ **Parallel Connectors:** To increase AC power output, the connector sockets are used to connect the two same type generators with special parallel cable GM9000PK sold by GENMAX. The connector sockets is only used to connect two inverter generators. They can not used for AC power output. The special parallel cable GM9000PK shall be purchased separately, and they shall be approved by certification body.
- ⑯ **Battery Charging Port:** Charge the generator battery.

Circuit Breaker: A circuit breaker interrupts the current when the whole circuit is overloaded.

CONTROL FUNCTIONS

OUTPUT DESCRIPTION OF THE AC SOCKET

When the voltage selector switch is set to 120V ONLY

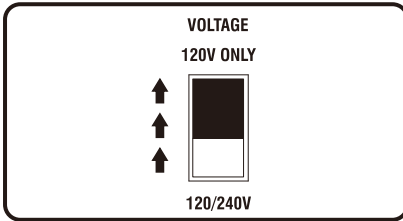

The voltage selector switch is set to 120V ONLY.

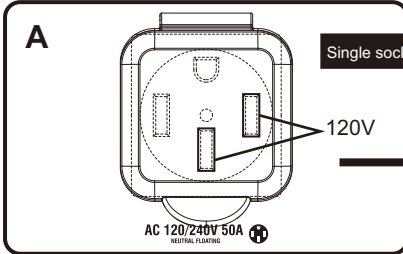

Output voltage can only be 120V and current 50A.
 $120\text{V}(\text{Voltage}) \times 50\text{A}(\text{Current}) = 6000\text{W}(\text{Output Power})$

ATTENTION: The total power output of the socket must not exceed the rated power of the generator.

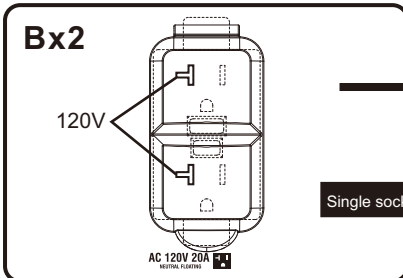

Output voltage 120V current 20A.
 $120\text{V}(\text{Voltage}) \times 20\text{A}(\text{Current}) = 2400\text{W}(\text{Output Power})$

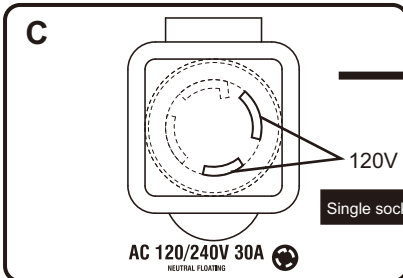

Output voltage can only be 120V and current 30A.
 $120\text{V}(\text{Voltage}) \times 30\text{A}(\text{Current}) = 3600\text{W}(\text{Output Power})$

CONTROL FUNCTIONS

When the voltage selector switch is set to 120/240V (Suitable for parallel)

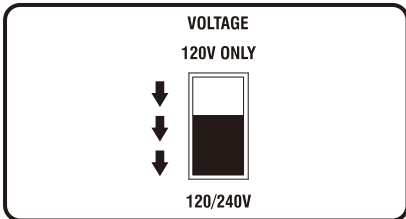

The voltage selector switch is set to 120/240V.
The voltage is 120/240V and two generators can be connected in parallel.

The output voltage is 120/240V, and the current is only 31.6A without parallel connection.

- ② & ③ **120V socket hole:** $120\text{V}(\text{Voltage}) \times 31.6\text{A}(\text{Current}) = 3792\text{W}(\text{Output Power})$
- ① **240V socket hole:** $240\text{V}(\text{Voltage}) \times 31.6\text{A}(\text{Current}) = 7584\text{W}(\text{Output Power})$

When two generators are connected in parallel, the socket can output 240V voltage at 50A current:

$240\text{V}(\text{Voltage}) \times 50\text{A}(\text{Current}) = 12000\text{W}(\text{Output Power})$

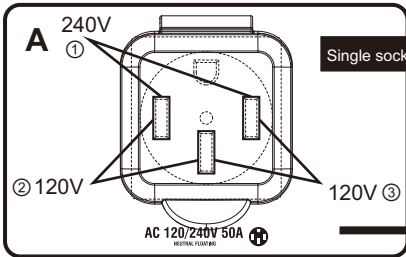

Single socket output

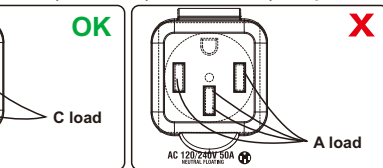
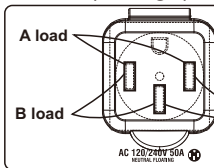

ATTENTION: ①②③ can output at the same time, but the total power output of the socket can not exceed the rated power of the generator, can not be connected to the same load.

ATTENTION: The total power output of the socket must not exceed the rated power of the generator.

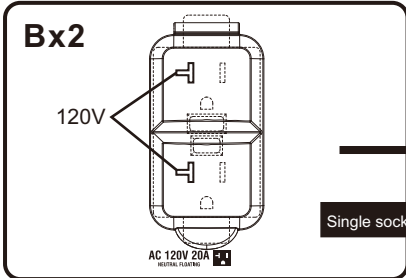

Single socket output

Output voltage 120V current 20A.
 $120\text{V}(\text{Voltage}) \times 20\text{A}(\text{Current}) = 2400\text{W}(\text{Output Power})$

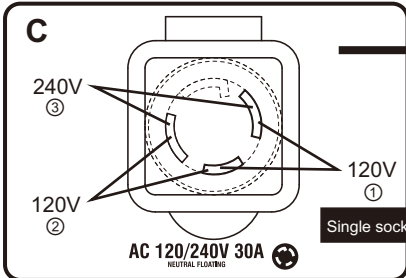

Single socket output

Output voltage 120V current 30A.

- ① & ② **120V socket hole:** $120\text{V}(\text{Voltage}) \times 30\text{A}(\text{Current}) = 3600\text{W}(\text{Output Power})$
- ③ **240V socket hole:** $240\text{V}(\text{Voltage}) \times 30\text{A}(\text{Current}) = 7200\text{W}(\text{Output Power})$

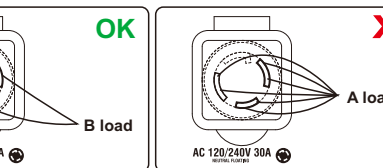
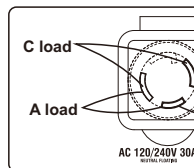

ATTENTION: ①②③ can output at the same time, but the total power output of the socket can not exceed the rated power of the generator, can not be connected to the same load.

CONTROL FUNCTIONS

DIGITAL DISPLAY CENTER

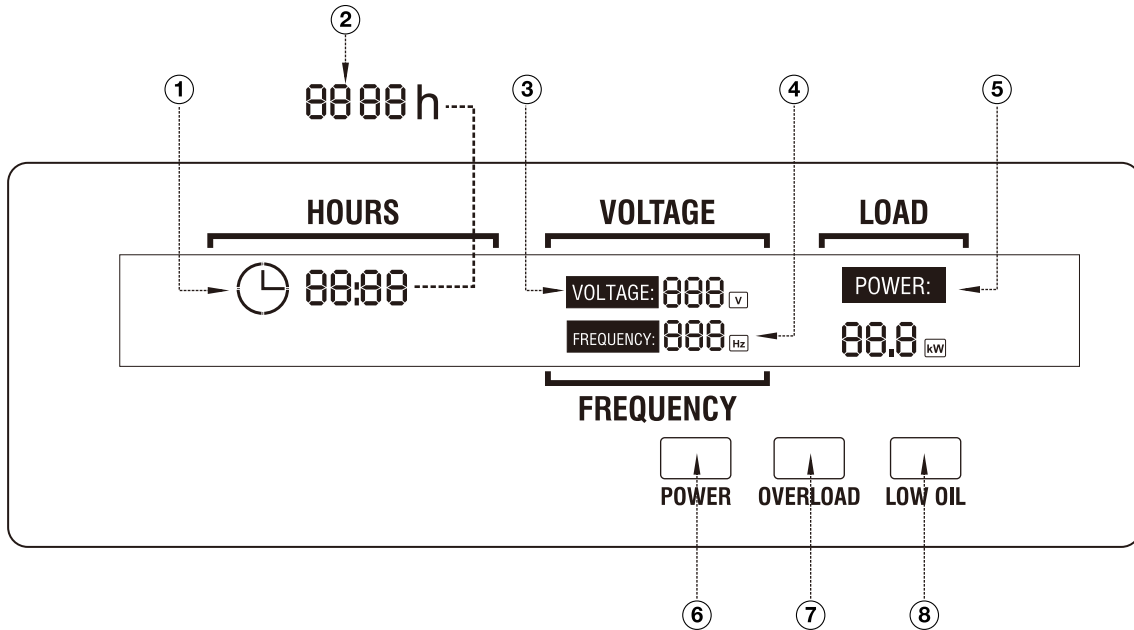

① 🕒 88:88: Represents single run time, goes from 0 at each startup.

② 8888 h: Represents total operation time of the generator. (Tip: The total operation time shall start to accumulate after the generator runs for one hour. It will not be displayed when the generator runs for less than one hour. The total operation time shall be accumulated by hours.) The two factors ① and ② are displayed alternately every 8 seconds.

③ **VOLTAGE**: Voltage display: 120V and 240V switch every 16 seconds.

④ **FREQUENCY**: Frequency display.

⑤ **LOAD**: Load power display.

⑥ **POWER**: Green light means normal operation.

⑦ **OVERLOAD**: Red light means the machine overload.

⑧ **LOW OIL**: Red light means the amount of oil is too low.

PREPARATIONS

1 Fuel

DANGER

- Fuel is flammable and toxic, please read the Safety Instruction carefully before refueling;
- Do not fuel too full, otherwise fuel will spill after fuel tank is warmed;
- After refueling, confirm that the fuel tank cap has been tightened.

ATTENTION

- After refueling, dry gasoline residue with a clean and soft cloth in time to avoid damaging plastic enclosure;
- Unleaded gasoline must be used, as leaded gasoline can seriously damage internal parts of the generator;

Remove fuel tank cap, and add gasoline to red horizontal indicating line oil level.
Fuel tank capacity: 6.9gal (26L)



2 Oil

No oil is filled into this generator when being delivered. Do not start up the generator without filling sufficient oil.

1. Please place the generator onto a horizontal plane surface;

2. Open the right exterior cover, unscrew oil dipstick;



3. Fill in 0.3gal(1L) oil (SAE 10W/30 oil is recommended, of which the grade is API standard Type SE or higher);

Don't go over the scale

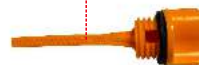

4. Cover the right panel.

PREPARATIONS

3 Pre-use Inspection



WARNING

Even if the generator is not in service, its important component may suddenly fails. Before the generator is started up, if any of following components is unable to work properly, please inspect and repair carefully.

Tip: The condition of the generator shall be inspected before using every time.

Pre-operation inspection

Project	Possible Causes	Probable Solutions
Fuel	Check fuel level in fuel tank of the generator.	Add fuel if necessary.
Oil	Check oil level of the generator.	Add oil if necessary.
	Check whether there is oil leaking.	
Abnormal conditions during operation	Check operating condition of the generator.	If there is any need, please do not hesitate to consult your dealer.
Battery	Check whether the battery is full.	See the "Battery Charging" page.

STARTING UP THE GENERATOR

GM9000iE Startup Procedure

1. Remove the load from all output ends;

2. Connect battery line before first use:
1. Remove the left panel cover;
2. Connect the positive and negative electrodes of the battery.



3. Turn the Fuel Switch clockwise to "ON";



4. Press the LOW IDLE Switch to "OFF";



5. Press the Main Switch to "ON";



6. Select Boot Mode:
a. Recoil Start: Pull the starting handle to start the generator.
b. Button Start: Press the button to start the generator.
c. Remote Start: Press the "START" button on the remote control to start the generator.



7. Plug in after started.



STARTING UP THE GENERATOR

GM9000iED/GM9000iEDC Startup Procedure

1. Remove the load from all output ends;

2. Connect battery line before first use:
1. Remove the left panel cover;
2. Connect the positive and negative electrodes of the battery.



3. Select the Fuel:

 a. Gasoline: Turn the fuel source switch to gasoline.



 b. LPG:
1. Connect the LPG hose to the LPG tank;
2. Tighten the other end of the LPG hose to the generator intake;
3. Turn the fuel source switch to LPG.



4. Press the LOW IDLE Switch to "OFF";



5. Press the Main Switch to "ON";



STARTING UP THE GENERATOR

6. Select Boot Mode :

- Recoil Start: Pull the starting handle to start the generator.
- Button Start: Press the button to start the generator.
- Remote Start: Press the "START" button on the remote control to start the generator.

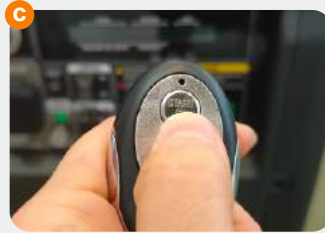

7. Plug in after started.



Remote Control Pairing

- Long press the start button for more than 5 seconds until the button red indicator is on;
- Press any key on the remote control;
- The red indicator of the start button will blink two or three times and then turns off, Remote start pairing is successful.

Tip: The remote control delivered with the generator has been paired successfully.



TIP

Remote Control Key Dormancy

When generator stops running for 5 days (120hours), while the main switch is not turned off, the remote control key cannot be used to start the generator again. At this time, you need to turn off the main switch and turn it on again, or press the one-key start button (or hand start) to start the generator, and the remote control key will be reactivated.

STARTING UP THE GENERATOR

COMMON PROBLEMS WITH STARTING THE GENERATOR:

Start the generator to run normally without output ?

(1) Check whether the green light of the GFCI socket is on.

If the green light is not on, press the RESET button after the generator is started to make the green light on.

Tip: When the generator is not started, the GFCI socket is in the protected state and the "RESET" button cannot be pressed.



(2) Check whether the circuit breaker switch is set to "ON".

If the circuit breaker switch is set to ON and there is no output, press the heat protection corresponding to the socket and use a multimeter to test whether the socket has voltage.



LPG startup is difficult ?

When both gasoline and LPG are present in the generator it is recommended to start the generator on gasoline first, allow the engine to stabilize then switch to LPG.

1. Ensure the LPG supply hose is securely attached and Close the LPG valve completely.



2. Fuel source rocker switch to "GASOLINE".

3. Follow the startup steps to start the generator.



4. Open the LPG valve completely.



5. Fuel source switch to "LPG".



Electric start and remote start no response ?

1. Check whether the positive and negative electrodes of the battery are correctly connected.

2. Check whether the battery is charged.

3. Check whether the remote control is powered on.

STARTING UP THE GENERATOR

INVERTER PARALLEL KIT OPERATION

50A Parallel Kits

This parallel kit is intended to be used only with GENMAX inverter generators. Please read safety information below before proceeding.

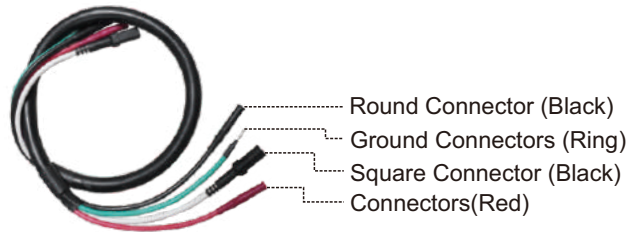

1. Make sure both engine switches are in the off position, and confirm the Low idle switches on both generators are turned off.
 2. Attach the ground terminal (green wire) from each end of the parallel cable to the corresponding ground terminal on each generator. Connect and tighten the ground wire.
 3. Connect the black and red parallel cable leads to the black parallel ports on each corresponding inverters control panel. **DO NOT connect two red leads or two black leads into the same inverter.** Pay attention: The white wire leave as it is, this just needed when parallel two Gm9000i.
 4. Connect the black square connector to the square socket of the generator.
 5. Start each generator and confirm that the green output indicator is illuminated on both.
- Tip:** When two generators are connected in parallel, the voltage selector switch must be placed at 120/240V before starting.
6. If using Low idle mode, turn both Low idle switches on after the generators are started.
 7. To shut down, turn off both generators and then remove the parallel cords.

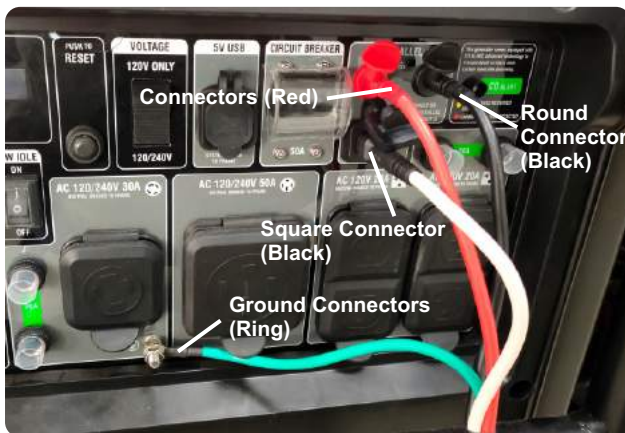

NOTICE: If high electrical loads are connected, turn the Low idle switch to the OFF position to reduce voltage changes. With the generators running, make sure both green output indicator lights are ON. If not ON, turn the generators off, restart the generators, and make sure both green output lights are ON.

SHUTTING DOWN THE GENERATOR

1. Unplug the power cord;

2. Select Stop Mode:

- Button Stop: Press the button to turn off the generator.
- Remote Stop: Press the "STOP" button on the remote control to turn off the generator.



3. Press the Main Switch to "OFF";

If not used for more than 48 hours, please turn off the Main Switch.

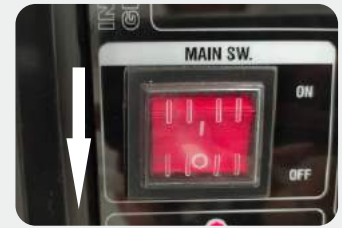

4. Turn off gasoline or LPG.



IMPORTANT NOTES

The above instructions for starting and stopping the generator are normal procedures. Users must follow standard procedures to start, use and shut down the generator.

1. If the user directly turns off the generator with the main switch, there may be a sound of muffler blasting, which is a normal phenomenon under abnormal operation.
2. When the battery is not connected or the battery is out of charge, if the user directly turns off the generator with the main switch, it may be difficult or impossible to start the cold machine, which is a normal phenomenon under abnormal operation.



USING THE GENERATOR

1 Service Environment of the Generator

- Applicable temperature: $-5^{\circ}\text{C} \sim 40^{\circ}\text{C}$;
- Applicable humidity: below 95%;
- Applicable altitude: regions below 1,500 m (It shall be used by reducing power in regions above 1,000 m).

Standard atmospheric condition

- Ambient temperature T_r : 298k (25°C)
- Relative air humidity Φ_r : 30%
- Absolute atmospheric pressure P_r : 100kPa

When actual environmental condition is inconsistent with the condition of output power of the generator set:

- Every 5°C of increase in ambient temperature will reduce the power of generator by about 2%.
- Every 30% of increase in relative humidity of air will reduce the power of generator by about 1.5%.
- Every 300 m rising of ASL will reduce the power the generator by about 4.5%.

2 Generator Wiring

- When the generator is connected to household power source as a backup power supply, the connection shall be carried out by a professional electrician or a person familiar with electricity.
- After connecting the load to the generator, check carefully whether electrical connection is safe and reliable. Improper electrical connection may cause generator damage, burning or fire.
- Avoid connecting this generator to commercial power outlet.
- When extending the cable, be sure not to exceed its length.
 - ① 60m cross-section area is 1.5mm^2
 - ② 100m cross-section area is 2.5mm^2
- The appearance of extension cable shall be protected by a layer of tough and elastic rubber cover (IEC25) or other substitutes.

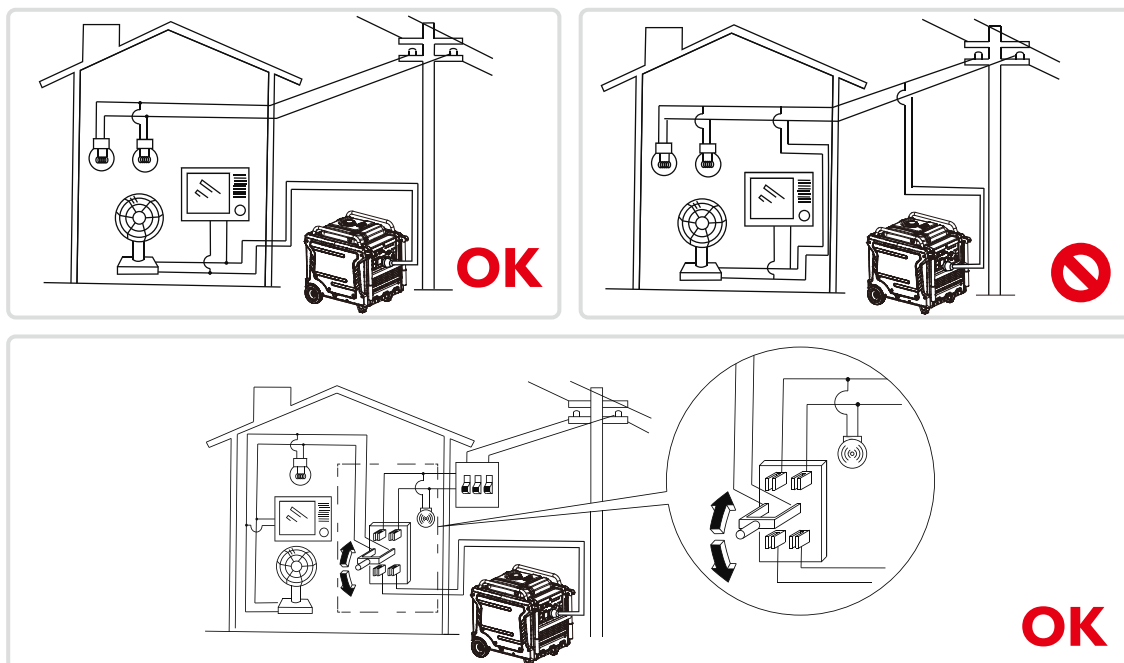

USING THE GENERATOR

Connection of AC power

WARNING

All electrical equipment shall be disconnected before inserting the plug.

ATTENTION

- Make sure that all electrical equipment, including wires and plugs, are in good condition before connecting to the generator;
- Make sure that all loads driven by the generator are within rated load range;
- Make sure that load current is within rated current range of rated socket.

Tip: Make sure that the generator set is grounded, and if electrical equipment requires grounding, the generator set must be grounded.

- ① Start up the engine;
- ② Turn energy-saving switch to "ON";
- ③ Insert the plug into AC outlet;
- ④ Make sure that AC indicator is lit up;
- ⑤ Switch on electrical equipment.

Tip: Before increasing engine speed, energy-saving switch must be switched to "OFF". If the generator set supplies power to multi loads or electrical equipment, start from large to small according to the size of each electrical equipment.

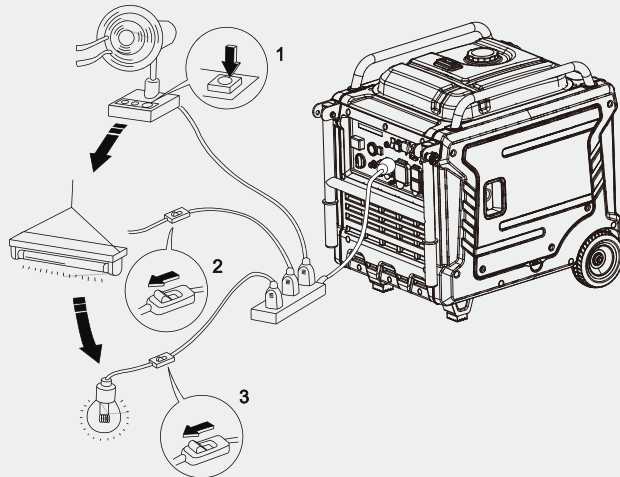

3 Generator Grounding

In order to prevent any damage to the generator caused by electric shock or improper electrical application, it is recommended that the generator is grounded with good conductor with insulating sheath.

- ① Please use grounding wire with sufficient electrical energy capacity;
- ② Connect one end of grounding wire reliable to grounding bolt on control panel of the generator set;
- ③ Insert grounding body (iron rod with a diameter of 5 ~ 10mm) 200mm below into the earth and lead it out with conductor;
- ④ Connect the other end of the grounding wire reliable to the led wire of grounding body.



Tip: How to change the grounding method please refer to the website: <https://www.genmaxpower.com/page/faq>

USING THE GENERATOR

4 Changing the Neutral Point

Applicable Model: GM9000iE

This generator is "neutral floating" state, if you want to change to a "neutral bonded" state, insert the Bonding Plug into the output socket of the generator to change the neutral floating to neutral bonded status.

Special Bonding Plug must be purchased separately.



NEMA L14-30P
Bonding Plug



5 Battery Charging

The battery storage time is generally about 6 months. If the generator is not used for a long time, the battery will run out of power. At this time, the battery should be charged. Replace the battery if it is damaged or fails to charge.

Hand start charging: Start the generator by hand, and the battery will be charged automatically when the generator runs.

Use an external power source for charging:

Connect the charger to the battery charging port on the generator panel and connect the mains to charge the battery.

Tip: The charging time is about 30-40 minutes.



WARNING

Do not start the generator while charging with an external power supply. Keep batteries away from fire sources. Keep the battery in a cool and dry place, away from direct sunlight. Keep batteries away from children.

ATTENTION

1. Charge properly

Keeping battery properly charged and discharged can prolong battery life. Maintaining a power level of 10%-90% in battery is beneficial for battery protection.

2. Choose the appropriate charging temperature

Battery charging temperature range: 0-45°C.

3. Avoid overcharging

Overcharging of battery must be avoided during the charging process. Overcharging of battery in any form will lead to serious damage to battery performance and even explosion.

SERVICE AND MAINTENANCE

Good maintenance and service is the best guarantee for safe, economical and zero-failure operation. It also contributes to environmental protection.

In order to keep the generator in good condition, you must inspect and maintain it regularly. The maintenance schedule is as follows:

Maintenance cycle		Each	First in 1 month or 20 hours	Then every three months or every 50 hours	100 hours per year or use
Item					
Engine oil	Check-fill	√			
	Replace		√	√	
Gearbox gear Oil (if any)	Check oil	√			
	Replace		√	√	
Air cleaner element	Inspection	√			
	Clean		√		
	Replace			√	
Settling cup (if any)	Clean				√
Spark plug	Clean-adjust				√*
Spark eliminator	Clean			√	
Idle speed (if any)**	Check-adjust				√
Valve clearance**	Check-adjust				√
Fuel tank and fuel filter***	Clean				√
Fuel line	Inspection	Every two years (Please replace if necessary)			
Cylinder head, piston	Remove carbon deposit**	Displacement < 225cc, every 125 hours; displacement capacity ≥ 225cc, every 250 hours.			
<p>* These items shall be replaced if necessary;</p> <p>** These items shall be maintained by the dealer authorized by the Company, unless the user has proper tools and maintenance ability.</p>					

ATTENTION

- If it often works under high temperature or high load, oil shall be changed every 25 hours;
- If it often works in dusty or harsh environment, air cleaner element shall be cleaned every 10 hours. If necessary, the air cleaner element shall be replaced every 25 hours;
- It shall be maintained on spot-inspection cycle and time, whichever is earlier;
- If maintenance cycle time has elapsed, perform the maintenance as soon as possible as per the table above.

SERVICE AND MAINTENANCE

WARNING

Please shut down the engine first before performing any maintenance. The engine shall be placed in a horizontal position. In order to prevent the engine from starting up, separate spark plug cap shall be separated from spark plug.

Do not use it indoors or use it in a tunnel, cave or other places ventilated poorly. Make sure that work area is well ventilated. Exhaust gas from the engine contains toxic gases, carbon oxides, and the inhalation can cause shock, loss of consciousness, and even death.

1 Spark Plug Inspection

Spark plug is an important part of the generator, which must be inspected regularly.

- 1.** Remove the left panel cover, and remove the high voltage pack;



- 2.** Insert the screwdriver into the sleeve, to screw it counterclockwise, and then remove the spark plug;



- 3.** Check whether there is discoloration, and remove carbon deposits. Check whether there is little pale to moderate brown on ceramic cores around center electrode of the spark plug;



- 4.** Check the model of spark plug and clearance.

Spark plug gap: 0.7-0.8mm

Standard spark:

BRAND	MODEL
NGK	BPR6ES
TORCH	F6RTC



Tip: The spark plug clearance is required to be measured by line thickness gauge, which shall be adjusted if necessary.

SERVICE AND MAINTENANCE

5. Install the spark plugs in reverse order of removal.
Spark plug torque: $22.5 \pm 2.5 \text{N.m}$ ($199 \pm 22 \text{in-lb}$)



Tip: If there is no torque wrench when installing the spark plug, a better estimation method is to screw it 1/4-1/2 turns by force after screwing it in place, but the spark plug shall be screwed to specified torque as soon as possible.

2 Adjustment of the Carburetor

The carburetor is an important components of the engine. The adjustment shall be carried out by a dealer with professional knowledge, professional data and equipment, to ensure that the adjustment is proper.

3 Replacement of Oil

WARNING

Do not drain the oil immediately after turning off the generator. Oil temperature is very high, when operating, take care to avoid scalding.

1. Put the generator on a horizontal plane, start the generator, run it for a few minutes to make it warm, then turn off the engine;

2. Open the right exterior cover, find the bolt that put the oil in;



3. 1. Remove the rubber plug;
2. Remove drain oil rubber plug ;
3. Use containers to catch waste oil, unscrew the drain oil bolt;
4. Tighten the drain bolt after the waste oil is discharged clean, cover the rubber plug.



SERVICE AND MAINTENANCE

4. Unscrew oil dipstick;



5. Refill oil to a proper level, tighten oil dipstick, cover external cover plate and tighten the knob.

Recommended oil: SAE S10W/30
Oil grade: API standard Model SJ or higher
Volume: 0.3gal



4 Oil Filter

It is recommended to clean the oil filter after the first operation of the generator. After that, it will be cleaned every 50 hours.

1. Drain the oil from the engine as in the previous oil drain change procedure, and then remove the oil filter next to it;



2. 1. Clean the impurities inside the filter plug. If the impurities are too much to clean, use detergent to clean;
2. After cleaning, blow dry with compressed air or air dry naturally and put back in the original position.



5 Air Filter

Dirty air cleaner may prevent air from flowing into the carburetor. In order to prevent failure of the carburetor, please maintain air cleaner regularly. If being used in a dusty environment, it shall be maintained frequently.

1. Remove screws , to remove cover plate of air cleaner ;



SERVICE AND MAINTENANCE

2. Clean foam cleaner element with cleaning solvent and blow it dry, Put a few drops of oil on the filter element.



ATTENTION

Be sure not to twist the foam cleaner element forcibly to avoid damage.

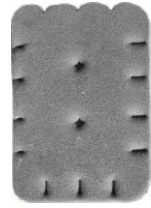

3. Put foam cleaner element into air cleaner;
Tip: Make sure that the surface of foam cleaner element is in close contact with air cleaner, and there shall be no gap leaking air. Be sure not to start the engine before air cleaner is assembled, because it will generate excessive toxic gas and wear the cylinder;



4. 1. Reassemble empty air cleaner cap back to original position, and tighten screws;
2. Assemble left outer cover and tighten bolts.



6 Fuel Filter Screen



WARNING

Be sure not to open fuel tank of the generator in a place where smoking or with flame.

1. Remove fuel tank cap and fuel tank filter screen.
2. Clean fuel tank filter screen with gasoline.
3. Wipe filter screen dry, and put it back into fuel tank.
4. Reassemble fuel tank cap.



ATTENTION

Be sure to screw fuel tank cap tight.

STORAGE AND TRANSPORT

1 Generator Storage

If it is stored long-term, in order to prevent aging, you shall take some storage measures.

1. Shut down generator.

2. Open fuel tank cap, to take out fuel filter screen. Pump all fuel in fuel tank into special fuel tank, and then reassemble fuel tank cap back.



3. Start up the engine to burn off fuel in the carburetor, and then shut it down.

Tip: Do not connect any electrical equipment. Running time of the engine depends on remaining fuel in the fuel tank.

4. Open generator left exterior cover and enter carburetor. Locate the clear plastic hose from the carburetor and place a suitable container under it to capture the drained fuel.



5. Loosen the carburetor drain screws until you see fuel draining from the carburetor.



6. Allow fuel to drain into the container and tighten the drain screws on the carburetor. Install the engine service panel.



7. Unscrew oil dipstick, and drain oil in the crankcase off. Fill new oil to upper oil limit, and then assemble oil dipstick.

STORAGE AND TRANSPORT

8. Gently pull startup handle until you feel resistance, allowing both inlet valve and exhaust valve to be closed.



9. Disconnect the battery cable.



10. Place the generator set in a clean and dry area.

2 *Generator Transport*

- When the generator set is transported, it shall be ensured that there is no fuel spilling;
- Do not fill excessive fuel into fuel tank;
- Do not run the generator, and avoid direct sunlight;
- Do not transport the generator set on rough road for long time.

TROUBLESHOOTING

Problem	Possible Causes	Probable Solutions
Engine will not start	FUEL RELATED: <ol style="list-style-type: none"> No fuel in tank or fuel valve closed. Choke not in START position, cold engine. Gasoline with more than 10% ethanol used. (E15, E20, E85, etc.) Low quality or deteriorated, old gasoline. Carburetor not primed. Dirty fuel passageways. Carburetor needle stuck. Fuel can be smelled in the air. Too much fuel in chamber. This can be caused by the carburetor needle sticking. Clogged Fuel Filter. 	FUEL RELATED: <ol style="list-style-type: none"> Fill fuel tank with fresh 87+ octane stabilizer-treated unleaded gasoline and open fuel valve. Do not use gasoline with more than 10% ethanol (E15, E20, E85, etc.). Move Choke to START position. Clean out ethanol rich gasoline from fuel system. Replace components damaged by ethanol. Use fresh 87+ octane stabilizer-treated unleaded gasoline only. Do not use gasoline with more than 10% ethanol (E15, E20, E85, etc.). Use fresh 87+ octane stabilizer-treated unleaded gasoline. Do not use gasoline with more than 10% ethanol (E15, E20, E85, etc.). Pull on Starter Handle to prime. Clean out passageways using fuel additive. Heavy deposits may require further cleaning. Gently tap side of carburetor float chamber with screwdriver handle. Turn Choke to RUN position. Remove spark plug and pull the start handle several times to air out the chamber. Reinstall spark plug and set Choke to START position. Replace Fuel Filter.
	IGNITION (SPARK) RELATED: <ol style="list-style-type: none"> Power Switch at OFF position. Spark plug cap not connected securely. Spark plug electrode wet or dirty. Incorrect spark plug gap. Spark plug cap broken. Circuit breaker tripped (electric start models only). Incorrect spark timing or faulty ignition system. 	IGNITION (SPARK) RELATED: <ol style="list-style-type: none"> Turn Power Switch to ON. Connect spark plug cap properly. Clean spark plug. Correct spark plug gap. Replace spark plug cap. Reset circuit breaker. Check wiring and starter motor if breaker continues to trip. Have qualified technician diagnose/repair ignition system.
	COMPRESSION RELATED: <ol style="list-style-type: none"> Cylinder not lubricated. Problem after long storage periods. Loose or broken spark plug. (Hissing noise will occur when trying to start.) Loose cylinder head or damaged head gasket. (Hissing noise will occur when trying to start.) Engine valves or tappets mis-adjusted or stuck. 	COMPRESSION RELATED: <ol style="list-style-type: none"> Pour tablespoon of oil into spark plug hole. Crank engine a few times and try to start again. Tighten spark plug. If that does not work, replace spark plug. If problem persists, may have head gasket problem, see #3. Tighten head. If that does not remedy problem, replace head gasket. Have qualified technician adjust/repair valves and tappets.
	ENGINE OIL RELATED: <ol style="list-style-type: none"> Low engine oil. Engine mounted on slope, triggering low oil shutdown. 	ENGINE OIL RELATED: <ol style="list-style-type: none"> Fill engine oil to proper level. Check engine oil before EVERY use. Operate engine on level surface. Check engine oil level.
	SPARK ARRESTOR RELATED: <ol style="list-style-type: none"> Spark Arrestor clogged with soot. 	SPARK ARRESTOR RELATED: <ol style="list-style-type: none"> Clean and replace Spark Arrestor.



Follow all safety precautions whenever diagnosing or servicing the generator or engine.

TROUBLESHOOTING

Problem	Possible Causes	Probable Solutions
Engine misfires	<ol style="list-style-type: none"> 1. Spark plug cap loose. 2. Incorrect spark plug gap or damaged spark plug. 3. Defective spark plug cap. 4. Old or low quality gasoline. 5. Incorrect compression. 	<ol style="list-style-type: none"> 1. Check cap and wire connections. 2. Re-gap or replace spark plug. 3. Replace spark plug cap. 4. Use only fresh 87+ octane stabilizer-treated unleaded gasoline. Do not use gasoline with more than 10% ethanol (E15, E20, E85, etc.). 5. Diagnose and repair compression. (Use Engine will not start: COMPRESSION RELATED section.)
Engine stops suddenly	<ol style="list-style-type: none"> 1. Carbon Monoxide level high. Red light on Carbon Monoxide Sensor illuminates. 2. CO Sensor Alarm flashes yellow continually shortly after starting. 3. CO Sensor Alarm flashes yellow continually after longer period of operation. 4. Low oil shutdown. 5. Fuel tank empty or full of impure or low quality gasoline. 6. Defective fuel tank cap creating vacuum, preventing proper fuel flow. 7. Faulty magneto. 8. Disconnected or improperly connected spark plug cap. 	<ol style="list-style-type: none"> 1. Leave area immediately and allow area to ventilate thoroughly. Only operate generator outside. 2. Carbon monoxide sensor malfunction. Sensor needs service. Do not use the Generator until the sensor is working properly. 3. Make sure to operate generator within rated ambient temperature; maintain minimum 5 ft. clearance from all sides. 4. Fill engine oil to proper level. Check engine oil before EVERY use. 5. Fill fuel tank with fresh 87+ octane stabilizer treated unleaded gasoline. Do not use gasoline with more than 10% ethanol (E15, E20, E85, etc.). 6. Test/replace fuel tank cap. 7. Have qualified technician service magneto. 8. Secure spark plug cap.
Engine stops when under heavy load	<ol style="list-style-type: none"> 1. Dirty air filter 2. Engine running cold. 	<ol style="list-style-type: none"> 1. Clean element. 2. Allow engine to warm up prior to operating equipment.
Engine knocks	<ol style="list-style-type: none"> 1. Old or low quality gasoline. 2. Engine overloaded. 3. Incorrect spark timing, deposit buildup, worn engine, or other mechanical problems. 	<ol style="list-style-type: none"> 1. Fill fuel tank with fresh 87+ octane stabilizer-treated unleaded gasoline. Do not use gasoline with more than 10% ethanol (E15, E20, E85, etc.). 2. Do not exceed equipment's load rating. 3. Have qualified technician diagnose and service engine.
Engine backfires	<ol style="list-style-type: none"> 1. Impure or low quality gasoline. 2. Engine too cold. 3. Intake valve stuck or overheated engine. 4. Incorrect timing. 	<ol style="list-style-type: none"> 1. Fill fuel tank with fresh 87+ octane stabilizer-treated unleaded gasoline. Do not use gasoline with more than 10% ethanol (E15, E20, E85, etc.). 2. Use cold weather fuel and oil additives to prevent backfiring. 3. Have qualified technician diagnose and service engine. 4. Check engine timing.
Attached device doesn't have power	<ol style="list-style-type: none"> 1. Device not plugged in properly. 2. Circuit Breaker tripped. 3. Product needs service. 	<ol style="list-style-type: none"> 1. Turn off and unplug the device, then plug it back in again and turn on. 2. Turn off and unplug device, reset Circuit Breaker, plug in device and turn on. 3. Have product repaired.
Attached device begins to operate abnormally	<ol style="list-style-type: none"> 1. Problem with device. 2. Rated load capacity exceeded. 	<ol style="list-style-type: none"> 1. Immediately unplug device. Have device repaired by a qualified technician, or replace device. 2. Lower the number of items plugged into the generator to stay within the rated capacity, or use a more powerful generator.



Follow all safety precautions whenever diagnosing or servicing the generator or engine.

TECHNICAL PARAMETERS

Item	GM9000iE	GM9000iED/GM9000iEDC
Rated Power (kW)	7.6	7.6(GAS.)/7.2(LPG)
Max. Power (kW)	9.0	9.0(GAS.)/8.55(LPG)
Engine Model	460i	460i
Valve Clearance	Input valve : 0.10~0.15 mm, Output valve : 0.15~0.20 mm	
Stroke x Bore (mm)	92x69	92x69
Engine Type	4-stroke	4-stroke
Displacement (cc)	458	458
Gas Distribution Mode	OHV	OHV
Cooling Mode	Forced cooling wind	
Rated Speed (RPM)	3600	3600
Starting Method	Recoil start/Electrical start/Remote start	
Fuel Tank Volume (gal)	6.9	6.9
Fuel Type and Grade	Vehicle-use unleaded gasoline	
Lubricating Oil Capacity (gal)	0.3	0.3
Lubricating Oil Model	SAE 10W/30	SAE 10W/30
Noise dB (at 7m)(25% load)	62	62
Rated Voltage (V)	120/240	120/240
Rated Frequency (Hz)	60	60
Rated Power Factor	1	1
Phase Number	Single phase	Single phase
Run Time @ 25% (h)	14	14
Fuel Consumption Rate (25% load)(L/h)	1.692	1.692
Fuel Consumption Rate (100% load)(L/h)	4.3	4.3
LPG Consumption Rate (25% load)(kg/h)	-	1.1
LPG Consumption Rate (100% load)(kg/h)	-	2.2
THD	≤3%	≤3%
Overall Dimension (in.)	30.9x22.6x29.3	30.9x22.6x29.3
Net Weight (lb.)	233.7	243.6

QUICK REFERENCE WATTAGE

Power Rating	Tool or Appliance	Running Watts	Starting Watts	
5500 - 12,000 Running Watts	1200 - 1800 Running Watts	Blender	300	650
		Coffee Maker	1500	
		Drill	600	900
		Fan	200	
		Furnace 1/4 hp	600	1000
		Game console	150	
		Hand sander	600	1200
		Hedge trimmer	450	1200
		Lamp	100	
		Laptop	800	
		LED/LCD TV	150	
		Microwave	1000	
		Modem/router	20	
		Paint sprayer	600	600
		Radio	100	
	Slow cooker	200	200	
	String trimmer	350	875	
	Sump Pump 1/3 hp	800	1300	
	Work light	1000		
	2800 - 3800 Running Watts	Belt sander	1200	2400
Chainsaw		1200	2400	
Circular saw		1200	2000	
Edger		950	2400	
Electric grill		1650		
Lawn mower		1200	2400	
Pressure washer		1200	2400	
Refrigerator		700	2200	
Washing machine		1150	2250	
Well pump		1000	2100	
Window AC 13k BTU		1800	2800	
Air compressor 1 hp		1600	4500	
Central AC 3 ton		5400	7200	
Electric Dryer		5400	6750	
Heat Pump 3 ton		3400	6500	
Water heater	4000			

†Chart for reference only. Check your device for ACTUAL wattage requirements.

HOW TO CALCULATE

Running Watts needed:

Total Running Watts of ALL items to be powered by the generator.

Starting Watts needed:

Add highest SINGLE Starting Watt to Total Running Watts needed above.

EXAMPLE

1 Calculate Running Watts:

Furnace	600
Lamp	100
Microwave	1000
Refrigerator	700
Total Running Watts	2400

2 Calculate Starting Watts:

Total Running Wattage	2400
Refrigerator	2200
Total Starting Watts	4600





In production management, based on orderly, efficient, scientific principles. trying to do as better as possible in product design, development, production, inspection, etc. to make our production can keep orderly. And will continue to make improvement to make sure that keep the competitiveness.

Welcome friends at home and abroad to visit and guide, work together to create brilliant.

GENMAX[®]

Caojie Industrial Park, Hechuan District, Chongqing

Phone 866-960-2920

E-mail service@genmaxpower.com

Http://www.genmaxpower.com/



Facebook



LinkedIn



YouTube

