

# INVERTER GENERATOR USER'S MANUAL



### GM2800iA/GM2800iAE

Portable Inverter Generator

2500 Running Watts | 2800 Peak Watts

### GM3500iA/GM3500iAE/GM3500iAD/GM3500iAED

Portable Inverter Generator

3200(GAS.)/2800(LPG) Running Watts | 3500(GAS.)/3100(LPG) Peak Watts



**WARNING:** SAVE THIS MANUAL FOR FUTURE REFERENCE



This manual contains important information regarding safety. Operation, maintenance and storage of this product. Before use, read carefully and understand all cautions, warnings, instructions and product labels. Failure to do so could result in serious personal injury and/or property damage.

**California  
Proposition 65 Warning**

The engine exhaust from this product contains chemicals known to the state of California to cause cancer, birth defects or other reproductive harm.

**California  
Proposition 65 Warning**

Certain components in this product and its related accessories contain chemicals known to the state of California to cause cancer, birth defects or other reproductive harm. Wash hands after handling.

**DISCLAIMERS:**

All information, illustrations and specifications in this manual are based on the latest information available at the time of publishing. The illustrations used in this manual are intended as representative reference views only. Moreover, because of our continuous product improvement policy, we may modify information, illustrations and/or specifications to explain and/or exemplify a product, service or maintenance improvement. We reserve the right to make any change at any time without notice. Some images may vary depending upon which model is shown.

**ALL RIGHTS RESERVED:**

No part of this publication may be reproduced or used in any form by any means - graphic, electronic or mechanical, including photocopying, recording, taping or information storage and retrieval systems - without the written permission of CHONGQING DINKING POWER MACHINERY CO., LTD

**⚠ DANGER**



This manual contains important instructions for operating this inverter generator. For your safety and the safety of others, be sure to read this manual thoroughly before operating the generator. Failure to properly follow all instructions and precautions can cause you and others to be seriously hurt or killed.

**UNPACKING**

**⚠ CAUTION**



Always have assistance when lifting the generator. The generator is heavy; lifting it could cause bodily harm.



Avoid cutting on or near staples to prevent personal injury.

**WHAT COMES IN THE BOX**

- Spark Plug Socket Wrench (1)
- Dual-Purpose Screwdriver (1)
- User Manual (1)
- Warranty Information (1)
- Funnel (1)
- 30RV Transfer Plug (GM3500iAED only)(1)
- Remote Control Key (GM2800iAE/GM3500iAE/GM3500iAED only)(1)
- LPG Hose With Regulator (GM3500iAD/GM3500iAED only)(1)

**Tools required** - box cutter or similar device.

- Carefully cut the packing tape on top of the carton.
- Remove socket wrench, oil and funnel and save for later.
- Carefully cut two sides of the carton to remove the generator.

# LIMITED WARRANTY

1. DURATION : One (1) year from the date of purchase by the original purchaser ( retail customer ) on products used solely for consumer applications; if a product is used for business, commercial, or industrial applications, the warranty period will be limited to ninety (90) days from the date of purchase.
2. WHO GIVES THIS WARRANTY (WARRANTOR):  
CHONGQING DINKING POWER MACHINERY CO., LTD
3. WHO RECEIVES THIS WARRANTY(PURCHASER):The original purchaser (other than for purposes of resale) of the Genmax's inverter.
4. WHAT PRODUCTS ARE COVERED BY THIS WARRANTY: Any portable generator supplied or manufactured by Warrantor.
5. WHAT IS COVERED UNDER THIS WARRANTY: Substantial defects on material and workmanship which occur within the duration of the warranty period.
6. WHAT IS NOT COVERED UNDER THIS WARRANTY:
  - A. Transportation charges for sending the product to Warrantor or its authorized service representative for warranty service, or for shipping repaired or replacement products back to the customer; these charges must be borne by the customer.
  - B. Damages caused by abuse, accident, shipping, misuse, overloading, modification, and the effects of corrosion, erosion and normal wear and tear.
  - C. Warranty is voided if the customer fails to install, maintain and operate the product in accordance with the instructions and recommendations set forth in the owner's manual(s), or if the product is used as rental equipment.
  - D. Pre-delivery service, i.e. assembly, oil or lubricants, and adjustment.
  - E. Items or service that are normally required to maintain the product, i.e. lubricants and filters.
  - F. Warrantor will not pay for repairs or adjustments to the product, or for any costs or labour, performed without Warrantor's prior authorization.

EXCLUSIONS AND LIMITATIONS : Warrantor makes no other warranty of any kind, express or implied. Implied warranties, including warranties of merchantability and of fitness for a particular purpose, are hereby disclaimed. This warranty service described above is the exclusive remedy under this warranty; liability for incidental and consequential damages is excluded to the extent permitted by law.

7. RESPONSIBILITIES OF PURCHASER UNDER THIS WARRANTY:
  - A. The purchaser must provide dated proof of purchase and must notify Warrantor within the warranty period.
  - B. Deliver or ship the serviced generator or component to the nearest Warrantor's authorized service representative. Freight costs, if any, must be borne by the purchaser.
8. HAVE QUESTIONS?  
Email: [warrantiesmallengines@gmail.com](mailto:warrantiesmallengines@gmail.com) Phone: 866-960-2920

---

## WARRANTY CARD

### PERSONAL INFORMATION

Name: \_\_\_\_\_  
Street Address: \_\_\_\_\_  
City, State, ZIP: \_\_\_\_\_  
Country: \_\_\_\_\_  
Phone Number: \_\_\_\_\_  
E-Mail: \_\_\_\_\_

### INVERTER INFORMATION

Model Number: \_\_\_\_\_  
Serial Number: \_\_\_\_\_  
Date Purchased: \_\_\_\_\_  
Purchased From: \_\_\_\_\_



# TABLE OF CONTENTS

<b>LIMITED WARRANTY</b>	<b>2</b>
<b>SAFETY WARNING</b>	<b>4</b>
<b>SAFETY INSTRUCTIONS</b>	<b>5</b>
<b>NAMES OF COMPONENTS</b>	<b>7</b>
<b>CONTROL FUNCTIONS</b>	<b>8</b>
<b>PREPARATIONS</b>	<b>12</b>
1.Fuel.....	12
2.Oil.....	12
3.Pre-operation inspection.....	13
<b>STARTING UP THE GENERATOR</b>	<b>14</b>
<b>SHUTTING DOWN THE GENERATOR</b>	<b>19</b>
<b>USING THE GENERATOR</b>	<b>20</b>
1.Service environment of the generator.....	20
2.Generator wiring.....	20
3.Generator grounding.....	21
4.Battery Charging.....	22
<b>SERVICE AND MAINTENANCE</b>	<b>23</b>
1.Spark plug inspection.....	24
2.Adjustment of the carburetor.....	25
3.Replacement of oil.....	25
4.Air filter.....	26
5.Fuel filter screen.....	27
<b>STORAGE AND TRANSPORT</b>	<b>28</b>
1.Generator storage.....	28
2.Generator transport.....	29
<b>TROUBLESHOOTING</b>	<b>30</b>
<b>TECHNICAL PARAMETERS</b>	<b>31</b>
<b>CIRCUIT DIAGRAM</b>	<b>32</b>
<b>CHOOSING A GENERATOR</b>	<b>37</b>

# SAFETY WARNING



Personal and property safeties of you and others are very vital. Please read the Safety Warning in the User's Manual and the decals of the generator set carefully. The Safety Warning can alert you to those potential hazards that could harm you and others. In front of each Safety Warning, there is one of four words "**DANGER**" "**WARNING**", "**ATTENTION**", and "**CAREFUL**". Details are as follows:

## DANGER

Failure to follow the instruction will result in being in peril of your life or extremely serious injury.

## WARNING

Failure to follow the instruction will result in being in peril of your life or very serious injury.

## CAREFUL

Failure to follow the instruction will result in minor injury.

## ATTENTION

Failure to follow the instruction will result in the damage to your generator set and other properties.

## CO TECHNICAL WARNING

CO DETECT technology monitors the accumulation of carbon monoxide (CO), a poisonous gas produced by engine exhaust when the generator is running. If CO Sensor detects unsafe elevated levels of CO gas, it automatically shuts off the engine. CO Sensor is not a substitute for an indoor carbon monoxide alarm or for safe operation. DO NOT allow engine exhaust fumes to enter a confined area through windows, doors, vents or other openings. Generators must ALWAYS be used outdoors, far away from occupied buildings with engine exhaust pointed away from people and buildings. Meets the requirements of ANSI/PGMA G300-2018.

## NEUTRAL FLOATING

For portable generators where the neutral is floating, the operator's manual shall include the following wording or equivalent:

The portable generator stator winding is isolated from the frame and from the AC receptacle ground pin; and Electrical devices that require a connection between one conductor pin and the grounded receptacle pin may not function properly.

# SAFETY INSTRUCTIONS

Before operating the generator, it will help you avoid accidents to read and understand the Manual and familiarize yourself with the safe operation procedures of the generator.



Please do not use indoors



Please do not use in humid environment

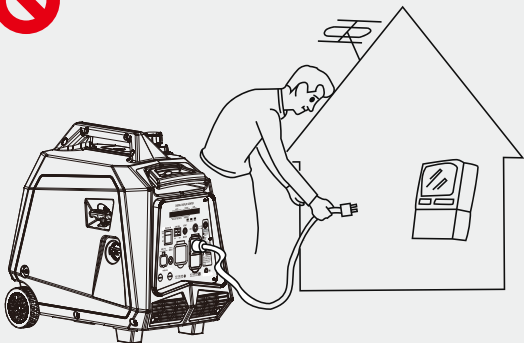

Please do not connect it to household appliances directly



Please do not smoke when refueling

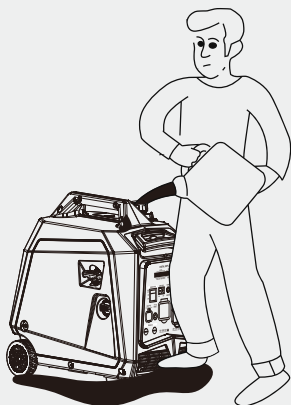

Please do not spill when refueling



Please shut down the generator before refueling

# SAFETY INSTRUCTIONS

## SAFETY LABELS AND DECALS

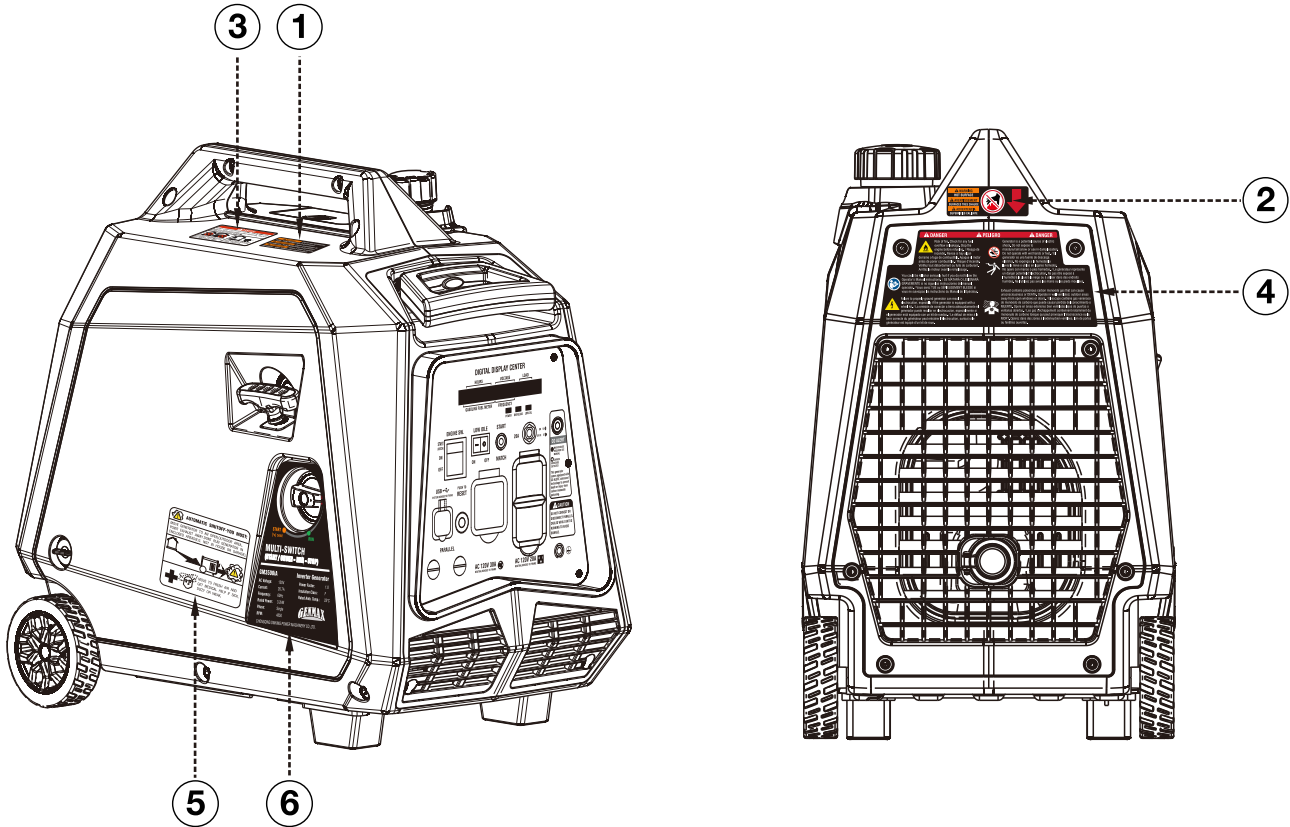

1

**⚠ WARNING** Cancer and reproductive harm - [www.P65Warnings.ca.gov/product](http://www.P65Warnings.ca.gov/product)

**⚠ AVERTISSEMENT** Cancer et problèmes de reproduction - [www.P65Warnings.ca.gov/product](http://www.P65Warnings.ca.gov/product)

**⚠ ADVERTENCIA** Cáncer y daños al sistema reproductor - [www.P65Warnings.ca.gov/product](http://www.P65Warnings.ca.gov/product)

Do not use the generator in a direction that the exhaust emission to the occupied structures, the sparks in the exhaust emission may start fires.

2

**⚠ WARNING** HOT SURFACE  
**⚠ AVERTISSEMENT** SURFACES TRÈS CHAUDES  
**⚠ ADVERTENCIA** SUPERFICIES CALIENTE

A hot exhaust system can cause serious burns, avoid contact if the engine has been running.

3

**⚠ DANGER**  
Using a generator indoors **CAN KILL YOU IN MINUTES**. Generator exhaust contains carbon monoxide. This is a poison you cannot see or smell.

**NEVER** use inside a home or garage. **EVEN IF** doors and windows are open.

Only use **OUTSIDE** and far away from windows, doors, and vents.

Do not use the generator in door or garage, the exhaust contains carbon monoxide, this is a poison you cannot see or smell, and it will kill you in minutes.

5

**⚠ AUTOMATIC SHUTOFF-YOU MUST:**

MOVE GENERATOR TO AN OPEN, OUTDOOR AREA. POINT EXHAUST AWAY. DON'T RUN GENERATOR IN ENCLOSED AREAS (E.G. NOT IN HOUSE OR GARAGE).

**+** MOVE TO FRESH AIR AND GET MEDICAL HELP IF SICK, DIZZY OR WEAK.

4

**⚠ DANGER** Risk of fire. Check for any fuel leaks before refueling. (Risque de incendie. Vérifier la présence de fuites de carburant avant de remplir le réservoir. (Riesgo de incendio. Verificar las fugas de combustible. Aguardar el motor antes de poner combustible. (Prepara il carburante. Verificare tutti i guarnimenti) (o tutti gli scambiatori. (Prepara el combustible. Verificar todos los sellos de los intercambiadores. (Prepara el combustible. Verificar todos los sellos de los intercambiadores.))

**⚠ PELIGRO** Generador es una fuente potencial de choque eléctrico. No toque el generador cuando esté encendido. (Le générateur est une source potentielle de choc électrique. Ne touchez pas le générateur lorsqu'il est en marche. (El generador es una fuente potencial de choque eléctrico. No toque el generador cuando esté encendido. (Il generatore è una fonte potenziale di scarica elettrica. Non toccare il generatore quando è in funzione. (O generatorul este o sursă potențială de șoc electric. Nu atingeți generatorul când este pornit.))

**⚠ DANGER** Exhaust contains poisonous carbon monoxide gas that can cause unconsciousness or death. Operate in well-ventilated outdoor areas. (El escape contiene gas venenoso de monóxido de carbono que puede causar pérdida del conocimiento o la muerte. Operar en áreas ventiladas bien ventiladas lejos de puertas o ventanas cerradas. (L'escape contient du gaz mortel de monoxyde de carbone lequel peut provoquer l'évanouissement ou la mort. Faire fonctionner dans une zone bien ventilée extérieure, loin de portes ou fenêtres closes.))

Before using the generator, please read the operation manual. Be careful with the shock hazard. Be careful, the fuel is flammable, do not add the fuel when the engine is running.

6

**START** (I) **CHOKE** **RUN** **STOP**

**MULTI-SWITCH**  
(START / CHOKE - RUN - STOP)

**GM3500iA** Inverter Generator

AC Voltage: 120V	Power Factor: 1.0
Current: 26.7A	Installation Class: F
Frequency: 60Hz	Rated Amb. Temp.: 25°C
Rated Power: 3.2kW	
Phase: Single	
RPM: 4850	

**GENMAX**

CHONGQING DINKING POWER MACHINERY CO., LTD.

# NAMES OF COMPONENTS

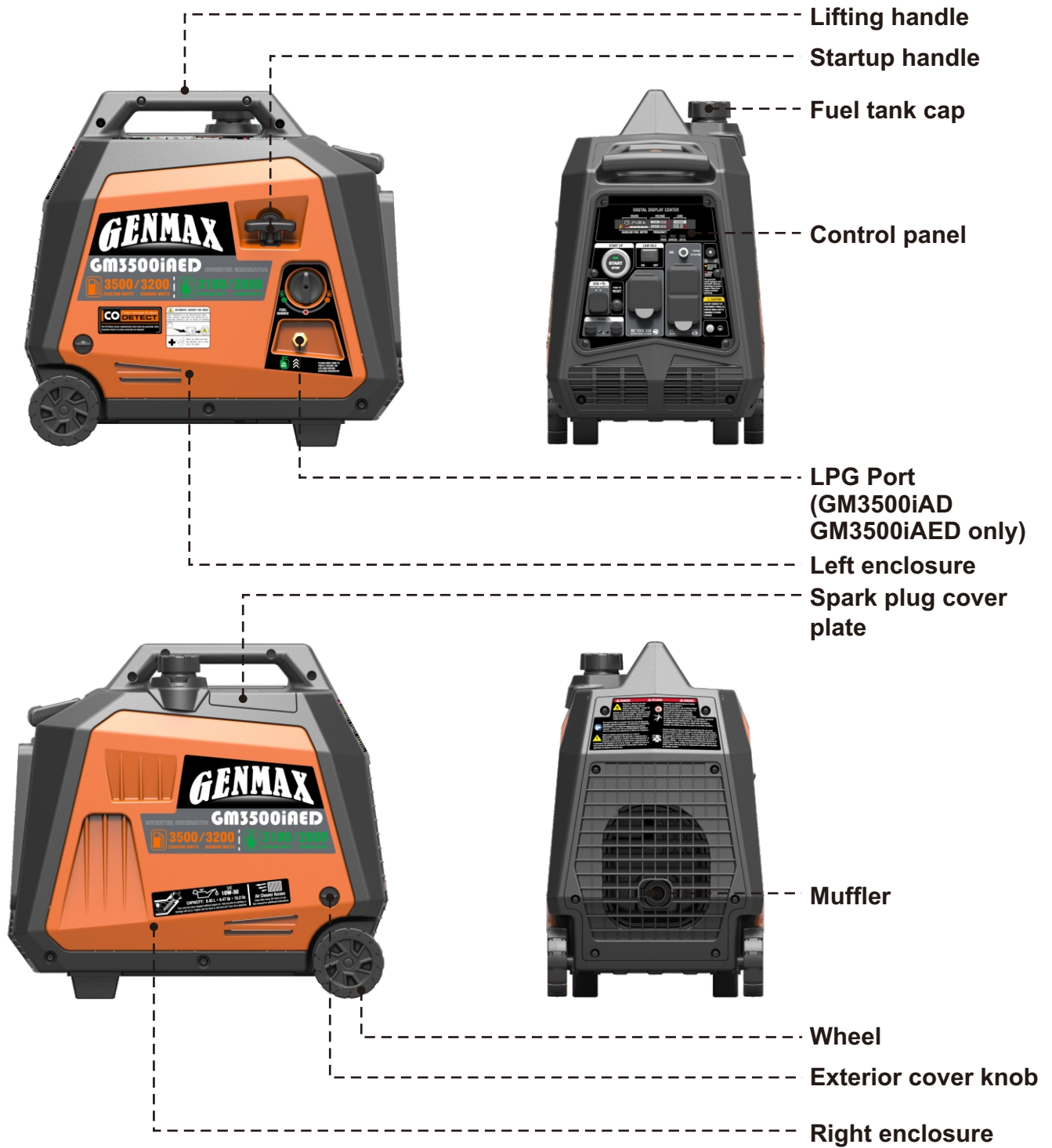



# CONTROL FUNCTIONS

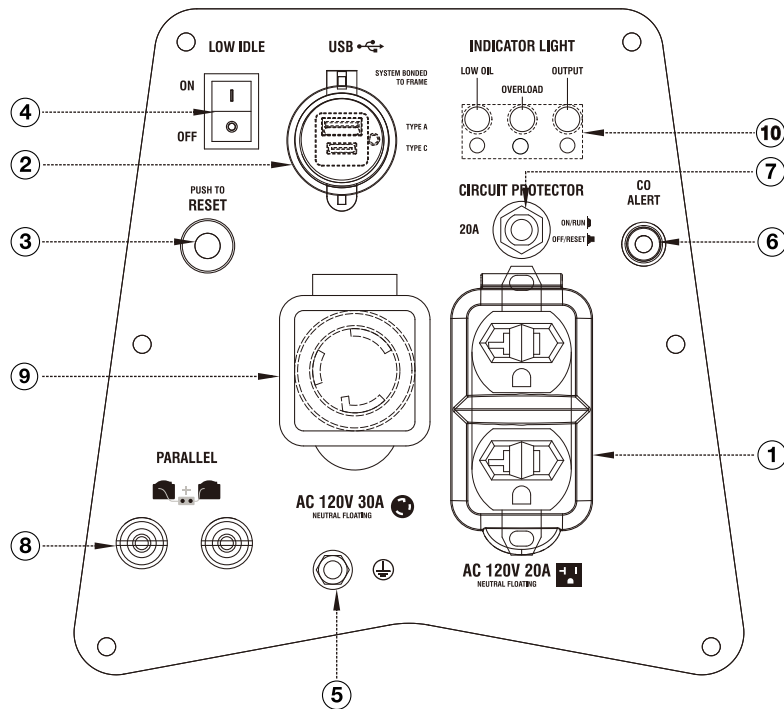

## CONTROL PANEL FEATURES GM2800iA/GM3500iA

- ① **120-Volt, 20-Amp Duplex Outlet:** The outlet is capable of carrying a maximum of 20 amps.
- ② **USB Duplex:** 5V DC that come in 1 amps and 2.1 amps.
- ③ **Reset:** If the inverter is overloaded, the reset breaker will trip. The engine will continue to run, but there will be no output from the inverter. Unplug the devices and reduce the load. Push in the reset breaker to reset it.
- ④ **Low Idle:** When turned to the ON position, the engine will sense the load needed and run at a slower RPM to save fuel.
- ⑤ **Ground Terminal:** The ground terminal is used to externally ground the inverter.
- ⑥ **CO Alarm:** Flashing red light: dangerous levels of carbon monoxide gas have built up leave immediately until area has aired out. Move generator to well-ventilated area before operation. Flashing yellow light: carbon monoxide sensor malfunction. Sensor needs service.
- ⑦ **AC Breaker:** If the inverter is overloaded, the reset breaker will trip to block current.
- ⑧ **Parallel Connectors:** To increase AC power output, the connector sockets are used to connect the two same type generator with special paralleling cords. The connector sockets is only used to the communication between the inverters, they can not used for AC power output. The special paralleling cords shall be purchase separately, and they shall be approved by certification body.
- ⑨ **120-Volt, 30-Amp Outlet:** The outlet is capable of carrying a maximum of 30 amps.
- ⑩ **Indicator Light:** Red light (LOW OIL) means that the amount of oil is too low, red light (OVERLOAD) means that the machine overload, green light (POWER) means normal operation. Frequency display, Load power display.

# CONTROL FUNCTIONS

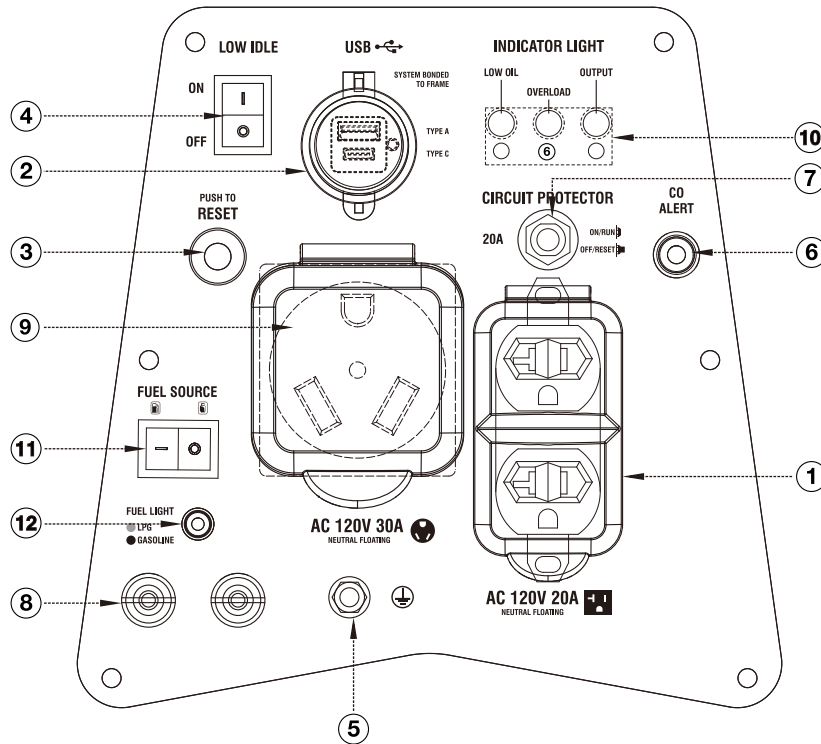

## CONTROL PANEL FEATURES GM3500iAD

- ① **120-Volt, 20-Amp Duplex Outlet:** The outlet is capable of carrying a maximum of 20 amps.
- ② **USB Duplex:** 5V DC that come in 1 amps and 2.1 amps.
- ③ **Reset:** If the inverter is overloaded, the reset breaker will trip. The engine will continue to run, but there will be no output from the inverter. Unplug the devices and reduce the load. Push in the reset breaker to reset it.
- ④ **Low Idle:** When turned to the ON position, the engine will sense the load needed and run at a slower RPM to save fuel.
- ⑤ **Ground Terminal:** The ground terminal is used to externally ground the inverter.
- ⑥ **CO Alarm:** Flashing red light: dangerous levels of carbon monoxide gas have built up leave immediately until area has aired out. Move generator to well-ventilated area before operation. Flashing yellow light: carbon monoxide sensor malfunction. Sensor needs service.
- ⑦ **AC Breaker:** If the inverter is overloaded, the reset breaker will trip to block current.
- ⑧ **Parallel Connectors:** To increase AC power output, the connector sockets are used to connect the two same type generator with special paralleling cords. The connector sockets is only used to the communication between the inverters, they can not used for AC power output. The special paralleling cords shall be purchase separately, and they shall be approved by certification body.
- ⑨ **120-Volt, 30-Amp Outlet:** The outlet is capable of carrying a maximum of 30 amps.
- ⑩ **Indicator Light:** Red light (LOW OIL) means that the amount of oil is too low, red light (OVERLOAD) means that the machine overload, green light (POWER) means normal operation. Frequency display, Load power display.
- ⑪ **Fuel Source:** Gasoline and LPG switch back and forth.
- ⑫ **Fuel Light:** LPG green light is steady on, gasoline blue light is steady on.

# CONTROL FUNCTIONS

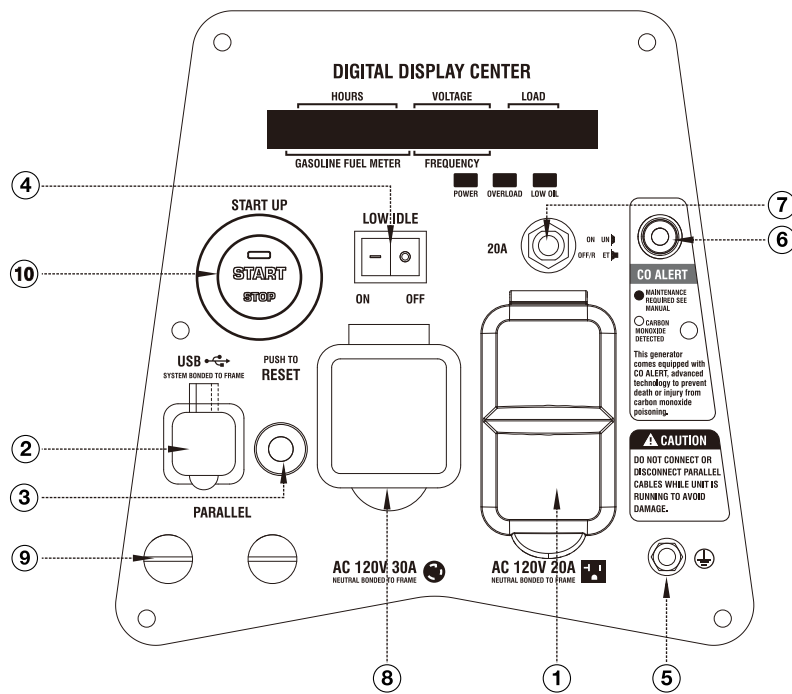

## CONTROL PANEL FEATURES GM2800iAE/GM3500iAE/GM3500iAED

- ① **120-Volt, 20-Amp Outlet:** The outlet is capable of carrying a maximum of 20 amps.
- ② **USB Duplex:** 5V DC that come in 1 amps and 2.1 amps.
- ③ **Reset:** If the inverter is overloaded, the reset breaker will trip. The engine will continue to run, but there will be no output from the inverter. Unplug the devices and reduce the load. Push in the reset breaker to reset it.
- ④ **Low Idle:** When turned to the ON position, the engine will sense the load needed and run at a slower RPM to save fuel.
- ⑤ **Ground Terminal:** The ground terminal is used to externally ground the inverter.
- ⑥ **CO Alarm:** Flashing red light: dangerous levels of carbon monoxide gas have built up leave immediately until area has aired out. Move generator to well-ventilated area before operation. Flashing yellow light: carbon monoxide sensor malfunction. Sensor needs service.
- ⑦ **AC Breaker:** If the inverter is overloaded, the reset breaker will trip to block current.
- ⑧ **120-Volt, 30-Amp Outlet:** The outlet is capable of carrying a maximum of 30 amps.
- ⑨ **Parallel Connectors:** To increase AC power output, the connector sockets are used to connect the two same type generator with special paralleling cords. The connector sockets is only used to the communication between the inverters, they can not used for AC power output. The special paralleling cords shall be purchase separately, and they shall be approved by certification body.
- ⑩ **One Push Start:** Press this button, the engine can start and stop.

# CONTROL FUNCTIONS

## DIGITAL DISPLAY CENTER

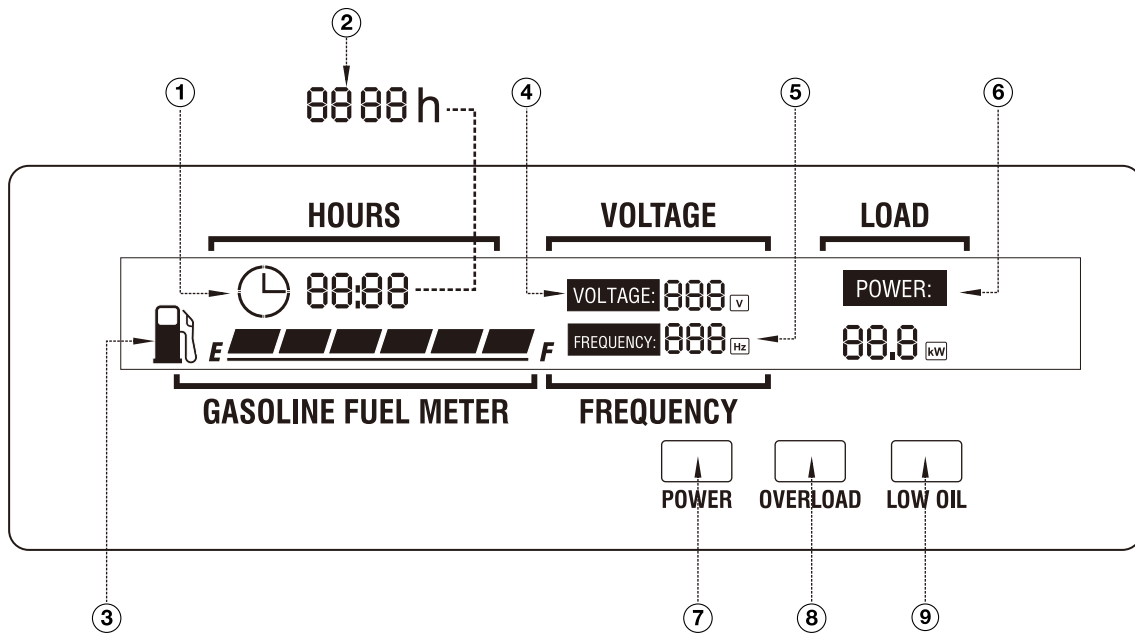

① 88:88 : Represents single run time, goes from 0 at each startup.

② 8888 h : Represents total operation time of the generator. (Tip: The total operation time shall start to accumulate after the generator runs for one hour. It will not be displayed when the generator runs for less than one hour. The total operation time shall be accumulated by hours.) The two factors ① and ② are displayed alternately every 8 seconds.

③ **GASOLINE FUEL METER**: Gasoline fuel level display.

④ **VOLTAGE**: Voltage display: 120V and 240V switch every 16 seconds.

⑤ **FREQUENCY**: Frequency display.

⑥ **LOAD**: Load power display.

⑦ **POWER**: Green light means normal operation.

⑧ **OVERLOAD**: Red light means the machine overload.

⑨ **LOW OIL**: Red light means the amount of oil is too low.

# PREPARATIONS

## 1 Fuel



### DANGER

- Fuel is flammable and toxic, please read the Safety Instruction carefully before refueling;
- Do not fuel too full, otherwise fuel will spill after fuel tank is warmed;
- After refueling, confirm that the fuel tank cap has been tightened.



### ATTENTION

- After refueling, dry gasoline residue with a clean and soft cloth in time to avoid damaging plastic enclosure;
- Unleaded gasoline must be used, as leaded gasoline can seriously damage internal parts of the generator;

Remove fuel tank cap, and add gasoline to red horizontal indicating line oil level.

Fuel tank capacity: 1.7gal



## 2 Oil

No oil is filled into this generator when being delivered. Do not start up the generator without filling sufficient oil.

1. Please place the generator onto a horizontal plane surface;

2. Loosen the knob on the right cover counterclockwise and remove the right cover;



3. Unscrew oil dipstick, Fill in 0.12gal oil (SAE 10W/30 oil is recommended, of which the grade is API standard Type SE or higher);



Don't go over the scale



4. Reinstall the right exterior cover and tighten the knob.

# PREPARATIONS

## 3 Pre-use Inspection



### WARNING

Even if the generator is not in service, its important component may suddenly fails. Before the generator is started up, if any of following components is unable to work properly, please inspect and repair carefully.

**Tip:** The condition of the generator shall be inspected before using every time.

#### Pre-operation inspection

Project	Possible Causes	Probable Solutions
Fuel	Check fuel level in fuel tank of the generator.	Add fuel if necessary.
Oil	Check oil level of the generator.	Add oil if necessary.
	Check whether there is oil leaking.	
Abnormal conditions during operation	Check operating condition of the generator.	If there is any need, please do not hesitate to consult your dealer.
Battery	Check whether the battery is full.	See the "Battery Charging" page.

# STARTING UP THE GENERATOR

## GM2800iA/GM3500iA Startup Procedure

1. Remove the load from all output ends;

2. Press the LOW IDLE switch to "OFF";

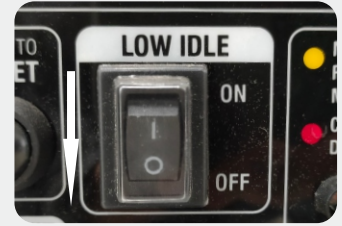

3. Turn the multi-switch to "START";

*Tip:* When hot engine is started up, it is unnecessary to close the choke valve, but turn the combination switch to "RUN".

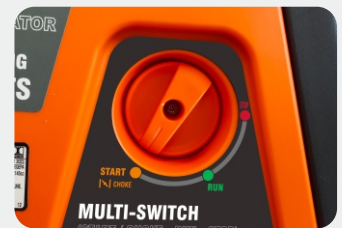

5. First gently pull startup handle, until guy cable is hooked tight, and then pull it with effort;

*Tip:* When pulling the hand starter, hold generator carrying handle firm, to prevent the generator from overturning.



6. After the generator starts, turn the multi-switch to "RUN";

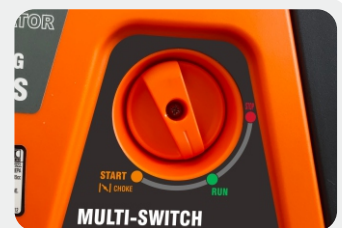

7. Plug in after started.



## GM3500iAD Startup Procedure

1. Remove the load from all output ends;

2. Select the Fuel:

a. Gasoline: Press the fuel source switch to gasoline.



# STARTING UP THE GENERATOR

LPG:

1. Connect the LPG hose to the LPG tank;
2. Tighten the other end of the LPG hose to the generator intake;
3. Press the fuel source switch to LPG;
4. If the cold engine fails to start many times, press the thickening valve button on the secondary pressure reducing valve for 2-3 seconds to thicken the gas. If it is still difficult to start, please refer to the start-up steps on page 18 of this manual to start.

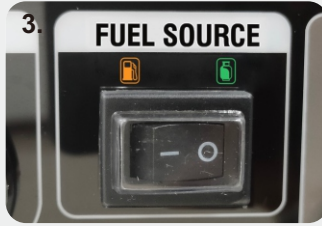

3. Press the LOW IDLE switch to "OFF";



4. Turn the multi-switch to "START";

**Tip:** When hot engine is started up, it is unnecessary to close the choke valve, but turn the combination switch to "RUN".

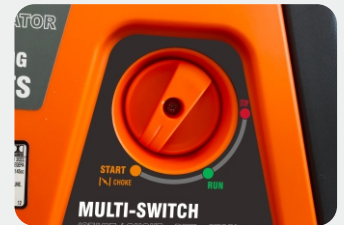

5. First gently pull startup handle, until guy cable is hooked tight, and then pull it with effort.

**Tip:** When pulling the hand starter, hold generator carrying handle firm, to prevent the generator from overturning.



6. After the generator starts, turn the multi-switch to "RUN";

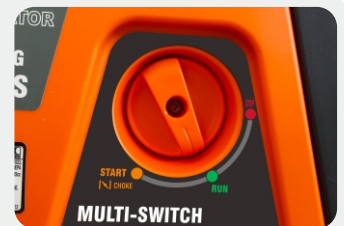

7. Plug in after started.





# STARTING UP THE GENERATOR

## GM2800iAE/GM3500iAE/GM3500iAED Startup Procedure

**1.** Remove the load from all output ends;

**2.** Connect battery line before first use:

1. Loosen the knob on the right cover and remove the cover;

2. Connect the positive and negative electrodes of the battery.

**Tip:** Connect the same color wires together, do not connect the wrong positive and negative wires.

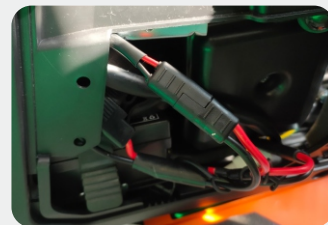

**3.** a. GM2800iAE/GM3500iAE: Turn the fuel switch to "ON".  
b. GM3500iAED: Turn the GAS/LPG switch to fuel gear.



LPG (GM3500iAED only):

1. Connect the LPG hose to the LPG tank;

2. Tighten the other end of the LPG hose to the generator intake;

3. Turn the fuel source switch to gas;

4. If the cold engine fails to start many times, press the thickening valve button on the secondary pressure reducing valve for 2-3 seconds to thicken the gas. If it is still difficult to start, please refer to the start-up steps on page 18 of this manual to start.

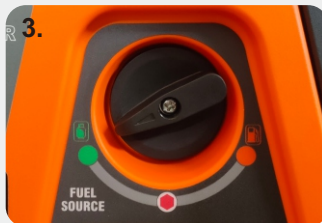

**4.** Press the LOW IDLE switch to "OFF";



# STARTING UP THE GENERATOR

## 5. Select Boot Mode:

- Hand Starting: Pull the starting handle to start the generator.
- One Button to Start: Press the one-click start button to start the generator.

**Tip:** If the green light keeps flashing fast, the generator does not start successfully. Press the button to turn off the green light, and press the button again to start the generator.

- Remote Start: Press the "OFF" button on the remote control to start the generator.



## 7. Plug in after started.



### Remote Control Pairing

- Long press the one-key start button for 5 seconds until the green light is steady on;
- Press the remote control ON or OFF, the one-button start button turns OFF the green light, and the remote control is paired successfully.

**Tip:** The remote control delivered with the generator has been paired successfully.



## COMMON PROBLEMS WITH STARTING THE GENERATOR:

### Start the generator to run normally without output ?

Check whether the green light of the GFCI socket is on.

If the green light is not on, press the RESET button after the generator is started to make the green light on.

**Tip:** When the generator is not started, the GFCI socket is in the protected state and the "RESET" button cannot be pressed.



# STARTING UP THE GENERATOR

## LPG startup is difficult ?

When both gasoline and propane are present in the generator it is recommended to start the generator on gasoline first, allow the engine to stabilize then switch to propane.

1. Ensure the LPG supply hose is securely attached and Close the LPG valve completely.



2. Fuel source rocker switch to "GASOLINE".  
3. Follow the startup steps to start the generator.



4. Open the LPG valve completely.



5. Fuel source switch to "LPG".



## Electric start and remote start no response ?

1. Check whether the positive and negative electrodes of the battery are correctly connected.
2. Check whether the battery is charged.
3. Check whether the remote control is powered on.

# SHUTTING DOWN THE GENERATOR

**1.** Unplug the power cord;

**2.** Select Stop Mode:

- a. One Button to Start: Press the one-click start button to turn off the generator.
- b. Remote Start: Press the "OFF" button on the remote control to turn off the generator.



**3.** a. GM2800iA/GM3500iA: Turn the multi-switch to "STOP".

b. GM2800iAE/GM3500iAE: Turn the fuel switch to "ON".

c. GM3500iAED: Turn the GAS/LPG switch to the middle to turn off the LPG or fuel.

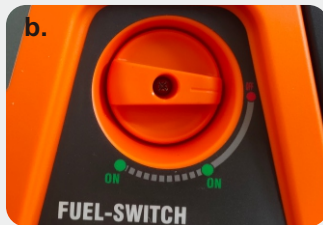

# USING THE GENERATOR

## 1 Service environment of the generator

- Applicable temperature:  $-5^{\circ}\text{C} \sim 40^{\circ}\text{C}$ ;
- Applicable humidity: below 95%;
- Applicable altitude: regions below 1,500 m (It shall be used by reducing power in regions above 1,000 m).

### Standard atmospheric condition

- Ambient temperature  $T_r$ : 298k ( $25^{\circ}\text{C}$ )
- Relative air humidity  $\Phi_r$ : 30%
- Absolute atmospheric pressure  $P_r$ : 100kPa

**When actual environmental condition is inconsistent with the condition of output power of the generator set:**

- Every  $5^{\circ}\text{C}$  of increase in ambient temperature will reduce the power of generator by about 2%.
- Every 30% of increase in relative humidity of air will reduce the power of generator by about 1.5%.
- Every 300 m rising of ASL will reduce the power the generator by about 4.5%.

## 2 Generator wiring

- When the generator is connected to household power source as a backup power supply, the connection shall be carried out by a professional electrician or a person familiar with electricity.
- After connecting the load to the generator, check carefully whether electrical connection is safe and reliable. Improper electrical connection may cause generator damage, burning or fire.
- Avoid connecting this generator to commercial power outlet.
- When extending the cable, be sure not to exceed its length.

① 60m cross-section area is  $1.5\text{mm}^2$

② 100m cross-section area is  $2.5\text{mm}^2$

- The appearance of extension cable shall be protected by a layer of tough and elastic rubber cover (IEC25) or other substitutes.

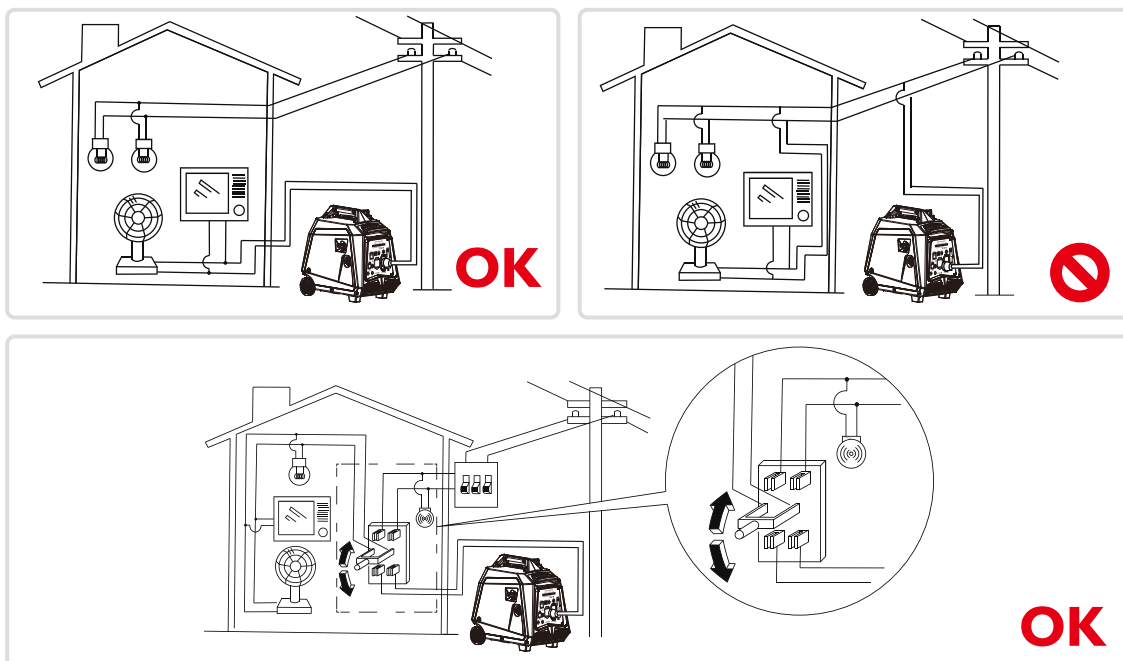

# USING THE GENERATOR

## Connection of AC power

### **WARNING**

All electrical equipment shall be disconnected before inserting the plug.

### **ATTENTION**

- Make sure that all electrical equipment, including wires and plugs, are in good condition before connecting to the generator;
- Make sure that all loads driven by the generator are within rated load range;
- Make sure that load current is within rated current range of rated socket.

**Tip:** Make sure that the generator set is grounded, and if electrical equipment requires grounding, the generator set must be grounded.

- ① Start up the engine;
- ② Turn energy-saving switch to "ON";
- ③ Insert the plug into AC outlet;
- ④ Make sure that AC indicator is lit up;
- ⑤ Switch on electrical equipment.

**Tip:** Before increasing engine speed, energy-saving switch must be switched to "OFF". If the generator set supplies power to multi loads or electrical equipment, start from large to small according to the size of each electrical equipment.

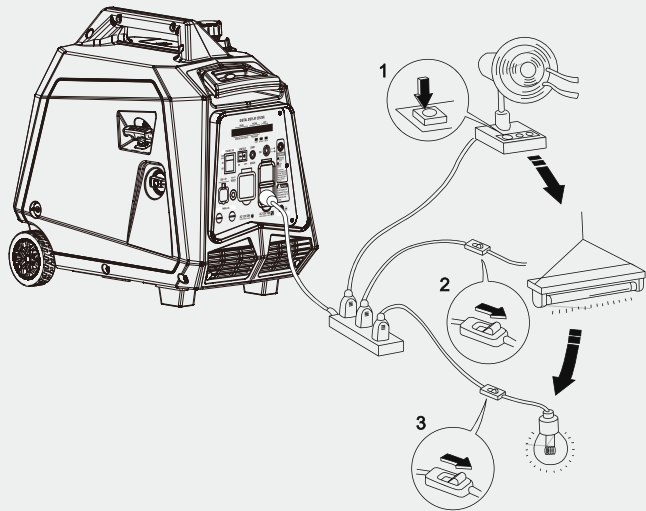

## **3** Generator grounding

In order to prevent any damage to the generator caused by electric shock or improper electrical application, it is recommended that the generator is grounded with good conductor with insulating sheath.

- ① Please use grounding wire with sufficient electrical energy capacity;
- ② Connect one end of grounding wire reliable to grounding bolt on control panel of the generator set;
- ③ Insert grounding body (iron rod with a diameter of 5 ~ 10mm) 200mm below into the earth and lead it out with conductor;
- ④ Connect the other end of the grounding wire reliable to the led wire of grounding body.



**Tip:** How to change the grounding method please refer to the website: <https://www.genmaxpower.com/page/faq>

# USING THE GENERATOR

## 4 Battery Charging

The battery storage time is generally about 6 months. If the generator is not used for a long time, the battery will run out of power. At this time, the battery should be charged. Replace the battery if it is damaged or fails to charge.

**Hand start charging:** Start the generator by hand, and the battery will be charged automatically when the generator runs.

**Use an external power source for charging:**

1. Loosen the knob on the right cover and remove the cover;

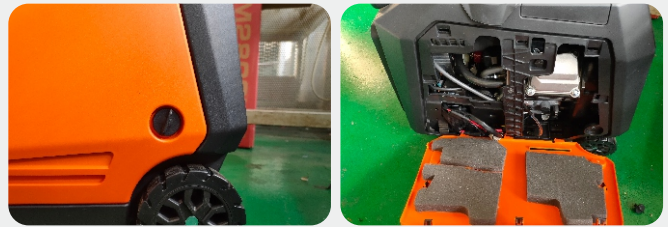

2. Connect the dedicated charger to the battery cable and charge the battery from the external power supply.  
*Tip:* The charging time is about 30-40 minutes.

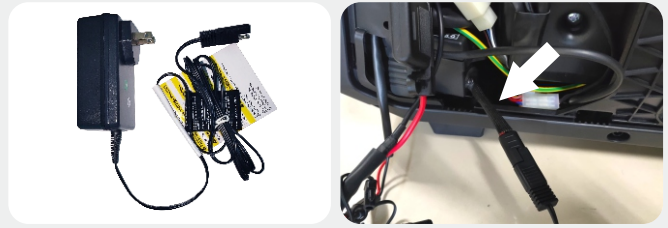

### **WARNING**

**Do not start the generator while charging with an external power supply. Keep batteries away from fire sources. Keep the battery in a cool and dry place, away from direct sunlight. Keep batteries away from children.**

### **ATTENTION**

#### 1. Charge properly

Keeping lithium-ion batteries properly charged and discharged can prolong battery life. Maintaining a power level of 10%-90% in lithium-ion batteries is beneficial for battery protection.

#### 2. Choose the appropriate charging temperature

Lithium battery charging temperature range: 0-45°C.

#### 3. Avoid overcharging

Overcharging of lithium-ion batteries must be avoided during the charging process. Overcharging of lithium-ion batteries in any form will lead to serious damage to battery performance and even explosion.

# SERVICE AND MAINTENANCE

Good maintenance and service is the best guarantee for safe, economical and zero-failure operation. It also contributes to environmental protection.

In order to keep the generator in good condition, you must inspect and maintain it regularly. The maintenance schedule is as follows:

Maintenance cycle		Item			
		Each	First in 1 month or 20 hours	Then every three months or every 50 hours	100 hours per year or use
Engine oil	Check-fill	√			
	Replace		√	√	
Gearbox gear Oil (if any)	Check oil	√			
	Replace		√	√	
Air cleaner element	Inspection	√			
	Clean		√		
	Replace			√	
Settling cup (if any)	Clean				√
Spark plug	Clean-adjust				√*
Spark eliminator	Clean			√	
Idle speed (if any)**	Check-adjust				√
Valve clearance**	Check-adjust				√
Fuel tank and fuel filter***	Clean				√
Fuel line	Inspection	Every two years (Please replace if necessary)			
Cylinder head, piston	Remove carbon deposit**	Displacement < 225cc, every 125 hours; displacement capacity ≥ 225cc, every 250 hours.			
<p>* These items shall be replaced if necessary;  ** These items shall be maintained by the dealer authorized by the Company, unless the user has proper tools and maintenance ability.</p>					

## ATTENTION

- If it often works under high temperature or high load, oil shall be changed every 25 hours;
- If it often works in dusty or harsh environment, air cleaner element shall be cleaned every 10 hours. If necessary, the air cleaner element shall be replaced every 25 hours;
- It shall be maintained on spot-inspection cycle and time, whichever is earlier;
- If maintenance cycle time has elapsed, perform the maintenance as soon as possible as per the table above.



# SERVICE AND MAINTENANCE

## **WARNING**

Please shut down the engine first before performing any maintenance. The engine shall be placed in a horizontal position. In order to prevent the engine from starting up, separate spark plug cap shall be separated from spark plug.

Do not use it indoors or use it in a tunnel, cave or other places ventilated poorly. Make sure that work area is well ventilated. Exhaust gas from the engine contains toxic gases, carbon oxides, and the inhalation can cause shock, loss of consciousness, and even death.

## **1 Spark plug inspection**

Spark plug is an important part of the generator, which must be inspected regularly.

- 1.** Remove decorative cover and spark plug cap of the generator;



- 2.** Insert the screwdriver into the sleeve, to screw it counterclockwise, and then remove the spark plug;



- 3.** Check whether there is discoloration, and remove carbon deposits. Check whether there is little pale to moderate brown on ceramic cores around center electrode of the spark plug;



- 4.** Check the model of spark plug and clearance.  
**Spark plug gap: 0.7-0.8mm**

**Standard spark:**

BRAND	MODEL
NGK	C7HSA
	CR6HSA
TORCH	A5RTC

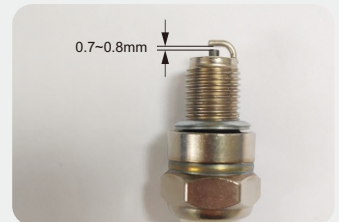

**Tip:** The spark plug clearance is required to be measured by line thickness gauge, which shall be adjusted if necessary.

# SERVICE AND MAINTENANCE

5. Install the spark plugs in reverse order of removal.  
**Spark cold torque: 12.5 N.m**

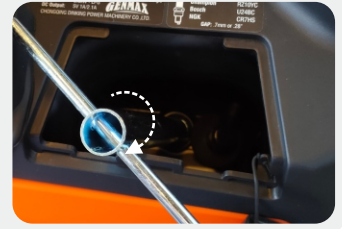

**Tip:** If there is no torque wrench when installing the spark plug, a better estimation method is to screw it 1/4-1/2 turns by force after screwing it in place, but the spark plug shall be screwed to specified torque as soon as possible.

## 2 Adjustment of the carburetor

The carburetor is an important components of the engine. The adjustment shall be carried out by a dealer with professional knowledge, professional data and equipment, to ensure that the adjustment is proper.

## 3 Replacement of oil

### **WARNING**

**Do not drain the oil immediately after turning off the generator. Oil temperature is very high, when operating, take care to avoid scalding.**

1. Put the generator on a horizontal plane, start the generator, run it for a few minutes to make it warm, then turn off the engine.

2. Loosen the knob on the right cover counterclockwise and remove the right cover ;

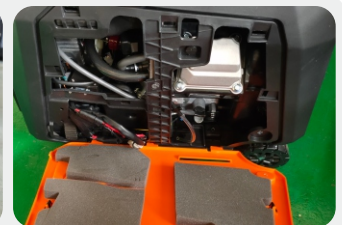

3. Unscrew oil dipstick.



# SERVICE AND MAINTENANCE

4. Place an oil pan under the engine, tilt the generator to quickly pour out oil; After discharging the oil, put the generator back on level ground.

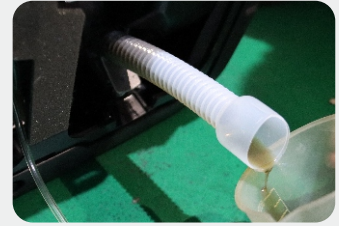

5. Refill oil to a proper level, tighten oil dipstick, cover external cover plate and tighten the knob.

**Recommended oil: SAE S10W/30**  
**Oil grade: API standard Model SJ or higher**  
**Volume: 0.12gal**

Don't go over the scale



## 4 Air filter

Dirty air cleaner may prevent air from flowing into the carburetor. In order to prevent failure of the carburetor, please maintain air cleaner regularly. If being used in a dusty environment, it shall be maintained frequently.

1. Loosen the knob on the right cover counterclockwise and remove the right cover;

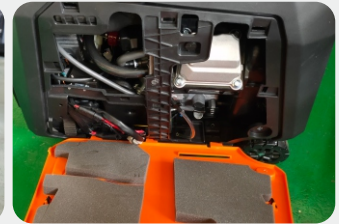

2. Remove screws, to remove cover plate of air cleaner;

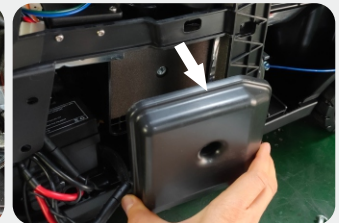
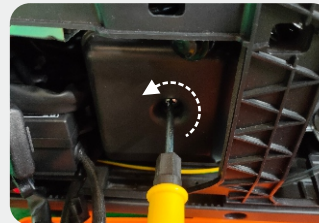

3. Clean foam cleaner element with cleaning solvent and blow it dry, Put a few drops of oil on the filter element.



### ATTENTION

Be sure not to twist the foam cleaner element forcibly to avoid damage.

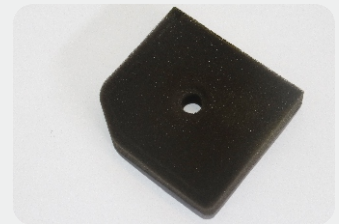

4. Put foam cleaner element into air cleaner;  
**Tip:** Make sure that the surface of foam cleaner element is in close contact with air cleaner, and there shall be no gap leaking air. Be sure not to start the engine before air cleaner is assembled, because it will generate excessive toxic gas and wear the cylinder;



## SERVICE AND MAINTENANCE

1. Reassemble empty air cleaner cap back to original position, and tighten screws;
2. Assemble right exterior cover and tighten knob.

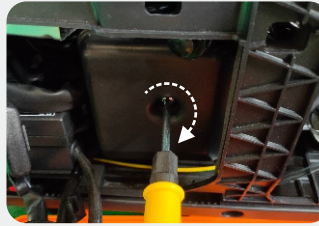

### 5 Fuel filter screen



#### **WARNING**

Be sure not to open fuel tank of the generator in a place where smoking or with flame.

1. Remove fuel tank cap and fuel tank filter screen.
2. Clean fuel tank filter screen with gasoline.
3. Wipe filter screen dry, and put it back into fuel tank.
4. Reassemble fuel tank cap.



#### **ATTENTION**

Be sure to screw fuel tank cap tight.

# STORAGE AND TRANSPORT

## 1 Generator storage

If it is stored long-term, in order to prevent aging, you shall take some storage measures.

1. Shut down generator.

2. Open fuel tank cap, to take out fuel filter screen. Pump all fuel in fuel tank into special fuel tank, and then reassemble fuel tank cap back.



3. Start up the engine to burn off fuel in the carburetor, and then shut it down.

**Tip:** Do not connect any electrical equipment. Running time of the engine depends on remaining fuel in the fuel tank.

4. Open the generator right exterior cover and enter the carburetor. Locate the clear plastic hose from the carburetor and place a suitable container under it to capture the drained fuel.

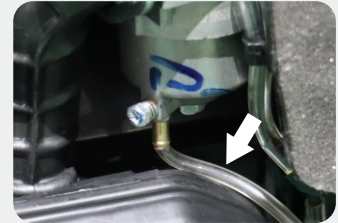

5. Loosen the carburetor drain screws until you see fuel draining from the carburetor.



6. Allow fuel to drain into the container and tighten the drain screws on the carburetor. Install the engine service panel.



7. Unscrew oil dipstick, and drain oil in the crankcase off. Fill new oil to upper oil limit, and then assemble oil dipstick.

# STORAGE AND TRANSPORT

8. Gently pull startup handle until you feel resistance, allowing both inlet valve and exhaust valve to be closed.



9. Disconnect the battery cable.  
(GM2800iAE/GM3500iAE/GM3500iAED only)



10. Place the generator set in a clean and dry area.

## 2 Generator transport

- When the generator set is transported, it shall be ensured that there is no fuel spilling;
- Do not fill excessive fuel into fuel tank;
- Do not run the generator, and avoid direct sunlight;
- Do not transport the generator set on rough road for long time.

# TROUBLESHOOTING

Problem	Possible Causes	Probable Solutions
Engine will not start	<b>FUEL RELATED:</b> <ol style="list-style-type: none"> <li>No fuel in tank or fuel valve closed.</li> <li>Choke not in START position, cold engine.</li> <li>Gasoline with more than 10% ethanol used. (E15, E20, E85, etc.)</li> <li>Low quality or deteriorated, old gasoline.</li> <li>Carburetor not primed.</li> <li>Dirty fuel passageways.</li> <li>Carburetor needle stuck. Fuel can be smelled in the air.</li> <li>Too much fuel in chamber. This can be caused by the carburetor needle sticking.</li> <li>Clogged Fuel Filter.</li> </ol>	<b>FUEL RELATED:</b> <ol style="list-style-type: none"> <li>Fill fuel tank with fresh 87+ octane stabilizer-treated unleaded gasoline and open fuel valve. <b>Do not use gasoline with more than 10% ethanol (E15, E20, E85, etc.).</b></li> <li>Move Choke to START position.</li> <li>Clean out ethanol rich gasoline from fuel system. Replace components damaged by ethanol. Use fresh 87+ octane stabilizer-treated unleaded gasoline only. <b>Do not use gasoline with more than 10% ethanol (E15, E20, E85, etc.).</b></li> <li>Use fresh 87+ octane stabilizer-treated unleaded gasoline. <b>Do not use gasoline with more than 10% ethanol (E15, E20, E85, etc.).</b></li> <li>Pull on Starter Handle to prime.</li> <li>Clean out passageways using fuel additive. Heavy deposits may require further cleaning.</li> <li><b>Gently</b> tap side of carburetor float chamber with screwdriver handle.</li> <li>Turn Choke to RUN position. Remove spark plug and pull the start handle several times to air out the chamber. Reinstall spark plug and set Choke to START position.</li> <li>Replace Fuel Filter.</li> </ol>
	<b>IGNITION (SPARK) RELATED:</b> <ol style="list-style-type: none"> <li>Power Switch at OFF position.</li> <li>Spark plug cap not connected securely.</li> <li>Spark plug electrode wet or dirty.</li> <li>Incorrect spark plug gap.</li> <li>Spark plug cap broken.</li> <li>Circuit breaker tripped (electric start models only).</li> <li>Incorrect spark timing or faulty ignition system.</li> </ol>	<b>IGNITION (SPARK) RELATED:</b> <ol style="list-style-type: none"> <li>Turn Power Switch to ON.</li> <li>Connect spark plug cap properly.</li> <li>Clean spark plug.</li> <li>Correct spark plug gap.</li> <li>Replace spark plug cap.</li> <li>Reset circuit breaker. Check wiring and starter motor if breaker continues to trip.</li> <li>Have qualified technician diagnose/repair ignition system.</li> </ol>
	<b>COMPRESSION RELATED:</b> <ol style="list-style-type: none"> <li>Cylinder not lubricated. Problem after long storage periods.</li> <li>Loose or broken spark plug. (Hissing noise will occur when trying to start.)</li> <li>Loose cylinder head or damaged head gasket. (Hissing noise will occur when trying to start.)</li> <li>Engine valves or tappets mis-adjusted or stuck.</li> </ol>	<b>COMPRESSION RELATED:</b> <ol style="list-style-type: none"> <li>Pour tablespoon of oil into spark plug hole. Crank engine a few times and try to start again.</li> <li>Tighten spark plug. If that does not work, replace spark plug. If problem persists, may have head gasket problem, see #3.</li> <li>Tighten head. If that does not remedy problem, replace head gasket.</li> <li>Have qualified technician adjust/repair valves and tappets.</li> </ol>
	<b>ENGINE OIL RELATED:</b> <ol style="list-style-type: none"> <li>Low engine oil.</li> <li>Engine mounted on slope, triggering low oil shutdown.</li> </ol>	<b>ENGINE OIL RELATED:</b> <ol style="list-style-type: none"> <li>Fill engine oil to proper level. Check engine oil before EVERY use.</li> <li>Operate engine on level surface. Check engine oil level.</li> </ol>
	<b>SPARK ARRESTOR RELATED:</b> <ol style="list-style-type: none"> <li>Spark Arrestor clogged with soot.</li> </ol>	<b>SPARK ARRESTOR RELATED:</b> <ol style="list-style-type: none"> <li>Clean and replace Spark Arrestor.</li> </ol>



**Follow all safety precautions whenever diagnosing or servicing the generator or engine.**

# TROUBLESHOOTING

Problem	Possible Causes	Probable Solutions
Engine misfires	<ol style="list-style-type: none"> <li>1. Spark plug cap loose.</li> <li>2. Incorrect spark plug gap or damaged spark plug.</li> <li>3. Defective spark plug cap.</li> <li>4. Old or low quality gasoline.</li> <li>5. Incorrect compression.</li> </ol>	<ol style="list-style-type: none"> <li>1. Check cap and wire connections.</li> <li>2. Re-gap or replace spark plug.</li> <li>3. Replace spark plug cap.</li> <li>4. Use only fresh 87+ octane stabilizer-treated unleaded gasoline. <b>Do not use gasoline with more than 10% ethanol (E15, E20, E85, etc.).</b></li> <li>5. Diagnose and repair compression. (Use <b>Engine will not start: COMPRESSION RELATED</b> section.)</li> </ol>
Engine stops suddenly	<ol style="list-style-type: none"> <li>1. Carbon Monoxide level high. Red light on Carbon Monoxide Sensor illuminates.</li> <li>2. CO Sensor Alarm flashes yellow continually shortly after starting.</li> <li>3. CO Sensor Alarm flashes yellow continually after longer period of operation.</li> <li>4. Low oil shutdown.</li> <li>5. Fuel tank empty or full of impure or low quality gasoline.</li> <li>6. Defective fuel tank cap creating vacuum, preventing proper fuel flow.</li> <li>7. Faulty magneto.</li> <li>8. Disconnected or improperly connected spark plug cap.</li> </ol>	<ol style="list-style-type: none"> <li>1. Leave area immediately and allow area to ventilate thoroughly. Only operate generator outside.</li> <li>2. Carbon monoxide sensor malfunction. Sensor needs service. Do not use the Generator until the sensor is working properly.</li> <li>3. Make sure to operate generator within rated ambient temperature; maintain minimum 5 ft. clearance from all sides.</li> <li>4. Fill engine oil to proper level. Check engine oil before EVERY use.</li> <li>5. Fill fuel tank with fresh 87+ octane stabilizer treated unleaded gasoline. Do not use gasoline with more than 10% ethanol (E15, E20, E85, etc.).</li> <li>6. Test/replace fuel tank cap.</li> <li>7. Have qualified technician service magneto.</li> <li>8. Secure spark plug cap.</li> </ol>
Engine stops when under heavy load	<ol style="list-style-type: none"> <li>1. Dirty air filter</li> <li>2. Engine running cold.</li> </ol>	<ol style="list-style-type: none"> <li>1. Clean element.</li> <li>2. Allow engine to warm up prior to operating equipment.</li> </ol>
Engine knocks	<ol style="list-style-type: none"> <li>1. Old or low quality gasoline.</li> <li>2. Engine overloaded.</li> <li>3. Incorrect spark timing, deposit buildup, worn engine, or other mechanical problems.</li> </ol>	<ol style="list-style-type: none"> <li>1. Fill fuel tank with fresh 87+ octane stabilizer-treated unleaded gasoline. <b>Do not use gasoline with more than 10% ethanol (E15, E20, E85, etc.).</b></li> <li>2. Do not exceed equipment's load rating.</li> <li>3. Have qualified technician diagnose and service engine.</li> </ol>
Engine backfires	<ol style="list-style-type: none"> <li>1. Impure or low quality gasoline.</li> <li>2. Engine too cold.</li> <li>3. Intake valve stuck or overheated engine.</li> <li>4. Incorrect timing.</li> </ol>	<ol style="list-style-type: none"> <li>1. Fill fuel tank with fresh 87+ octane stabilizer-treated unleaded gasoline. <b>Do not use gasoline with more than 10% ethanol (E15, E20, E85, etc.).</b></li> <li>2. Use cold weather fuel and oil additives to prevent backfiring.</li> <li>3. Have qualified technician diagnose and service engine.</li> <li>4. Check engine timing.</li> </ol>
Attached device doesn't have power	<ol style="list-style-type: none"> <li>1. Device not plugged in properly.</li> <li>2. Circuit Breaker tripped.</li> <li>3. Product needs service.</li> </ol>	<ol style="list-style-type: none"> <li>1. Turn off and unplug the device, then plug it back in again and turn on.</li> <li>2. Turn off and unplug device, reset Circuit Breaker, plug in device and turn on.</li> <li>3. Have product repaired.</li> </ol>
Attached device begins to operate abnormally	<ol style="list-style-type: none"> <li>1. Problem with device.</li> <li>2. Rated load capacity exceeded.</li> </ol>	<ol style="list-style-type: none"> <li>1. Immediately unplug device. Have device repaired by a qualified technician, or replace device.</li> <li>2. Lower the number of items plugged into the generator to stay within the rated capacity, or use a more powerful generator.</li> </ol>



**Follow all safety precautions whenever diagnosing or servicing the generator or engine.**



## TECHNICAL PARAMETERS

Item	GM2800iA/GM2800iAE	GM3500iA/GM3500iAE	GM3500iAD GM3500iAED
Rated Power (kW)	2.5	3.2	3.2(GAS.)/2.8(LPG)
Max. Power (kW)	2.8	3.5	3.5(GAS.)/3.1(LPG)
Engine Model	164F/P	164F/P	164F/P
Valve Clearance	Input valve : 0.03~0.08mm, Output valve : 0.03~0.08mm		
Stroke x Bore (mm)	64x45	64x45	64x45
Engine Type	4-stroke	4-stroke	4-stroke
Displacement (cc)	145	145	145
Gas Distribution Mode	OHV	OHV	OHV
Cooling Mode	Forced cooling wind		
Rated Speed (RPM)	4500	4850	4850
Starting Method	GM2800iA/GM3500iA/GM3500iAD: Recoil start GM2800iAE/GM3500iAE/GM3500iAED: Recoil start/Electrical start/Remote start		
Fuel Tank Volume (gal)	1.7	1.0	1.0
Fuel Type and Grade	Vehicle-use unleaded gasoline		
Lubricating Oil Capacity (gal)	0.12	0.12	0.12
Lubricating Oil Model	SAE 10W/30	SAE 10W/30	SAE 10W/30
Noise dB (at 7m)(25% load)	62	62	62
Rated Voltage (V)	120	120	120
Rated Frequency (Hz)	60	60	60
Rated Power Factor	1	1	1
Phase Number	Single phase	Single phase	Single phase
Run Time @ 25% (h)	10	9	9(GAS.)
Fuel Consumption Rate (25% load)(L/h)	0.75	0.85	0.85
Fuel Consumption Rate (100% load)(L/h)	1.5	1.9	1.9
LPG Consumption Rate (25% load)(kg/h)	-	-	0.425
LPG Consumption Rate (100% load)(kg/h)	-	-	1.25
THD	≤3%	≤3%	≤3%
Overall Dimension (in.)	20.7x12.2x19.7	20.7x12.2x19.7	20.7x12.2x19.7
Net Weight (lb.)	51/54	51/54	56.2

# CIRCUIT DIAGRAM

## GM2800iA/GM3500iA SCHEMATICS

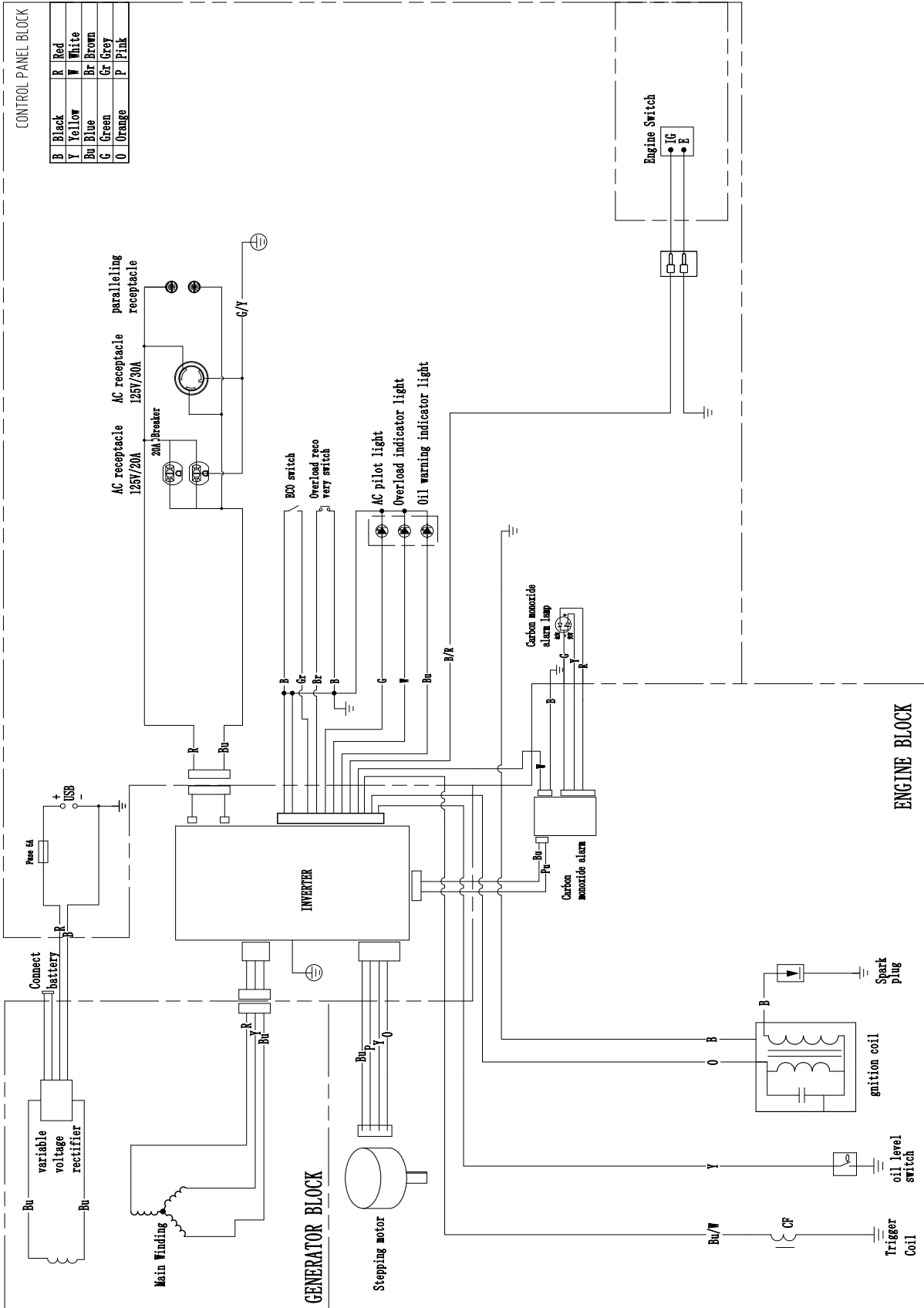

# CIRCUIT DIAGRAM

## GM2800iAE/GM3500iAE SCHEMATICS

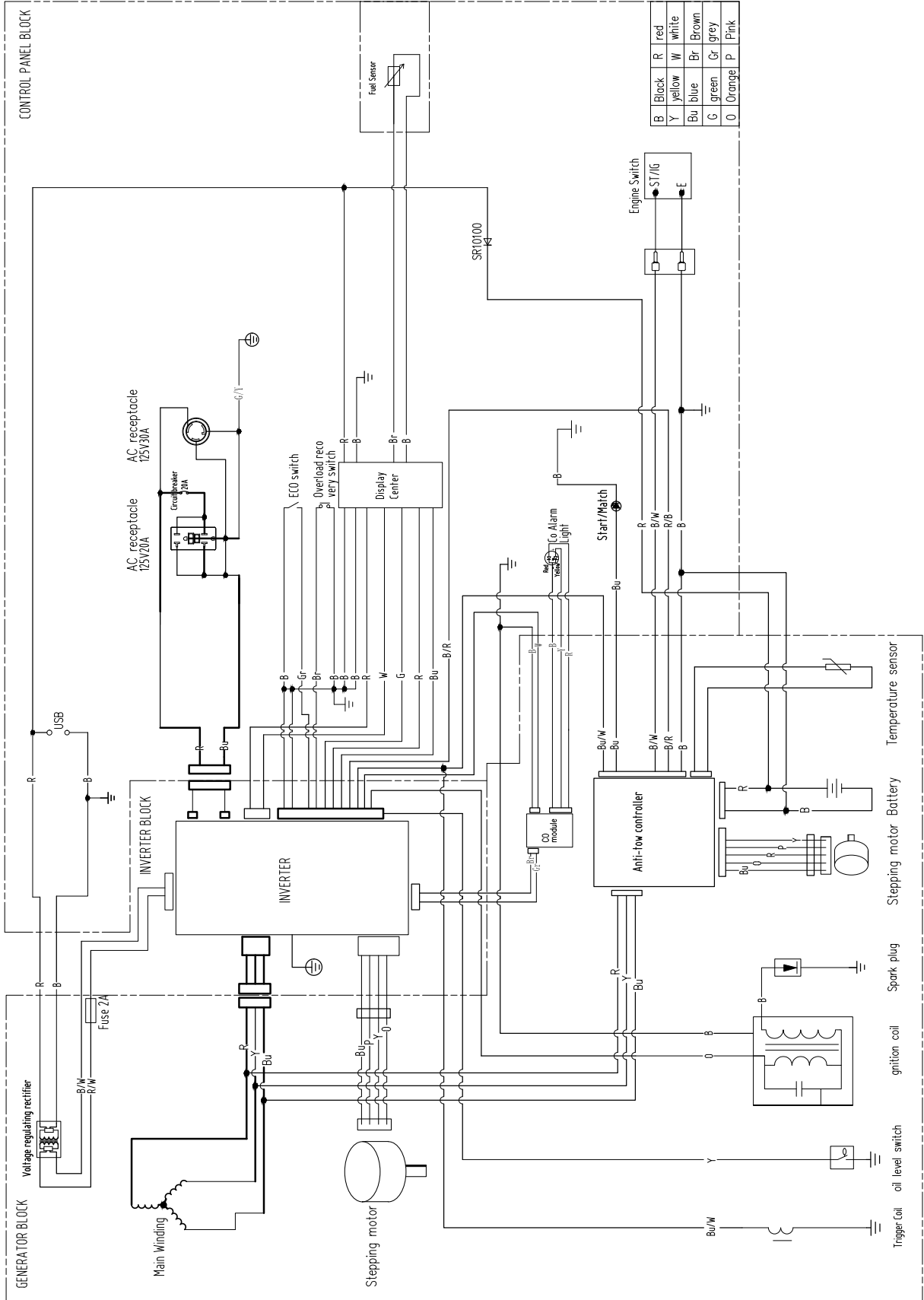

# CIRCUIT DIAGRAM

## GM3500iAD SCHEMATICS

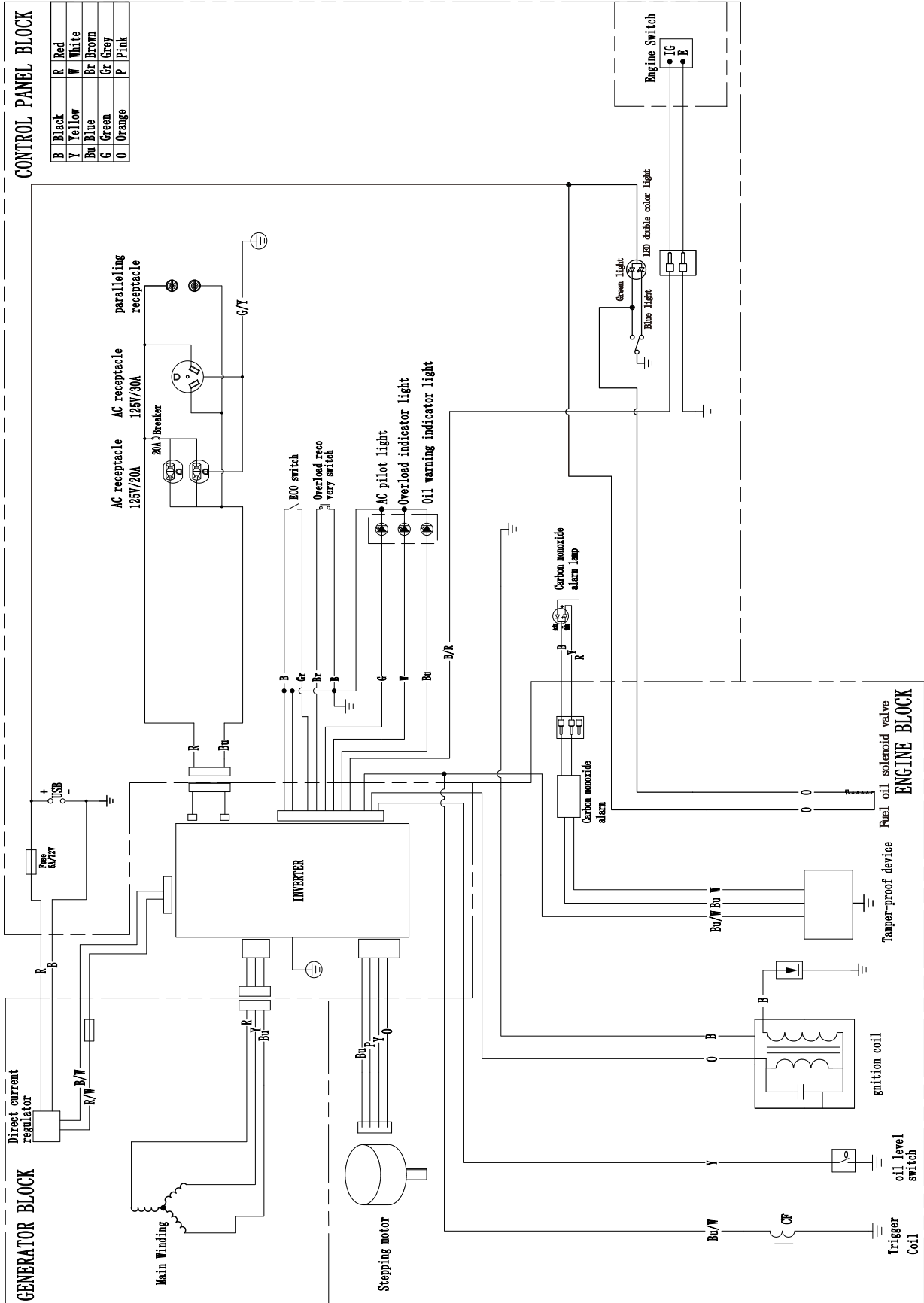

# CIRCUIT DIAGRAM

## GM3500iAED SCHEMATICS

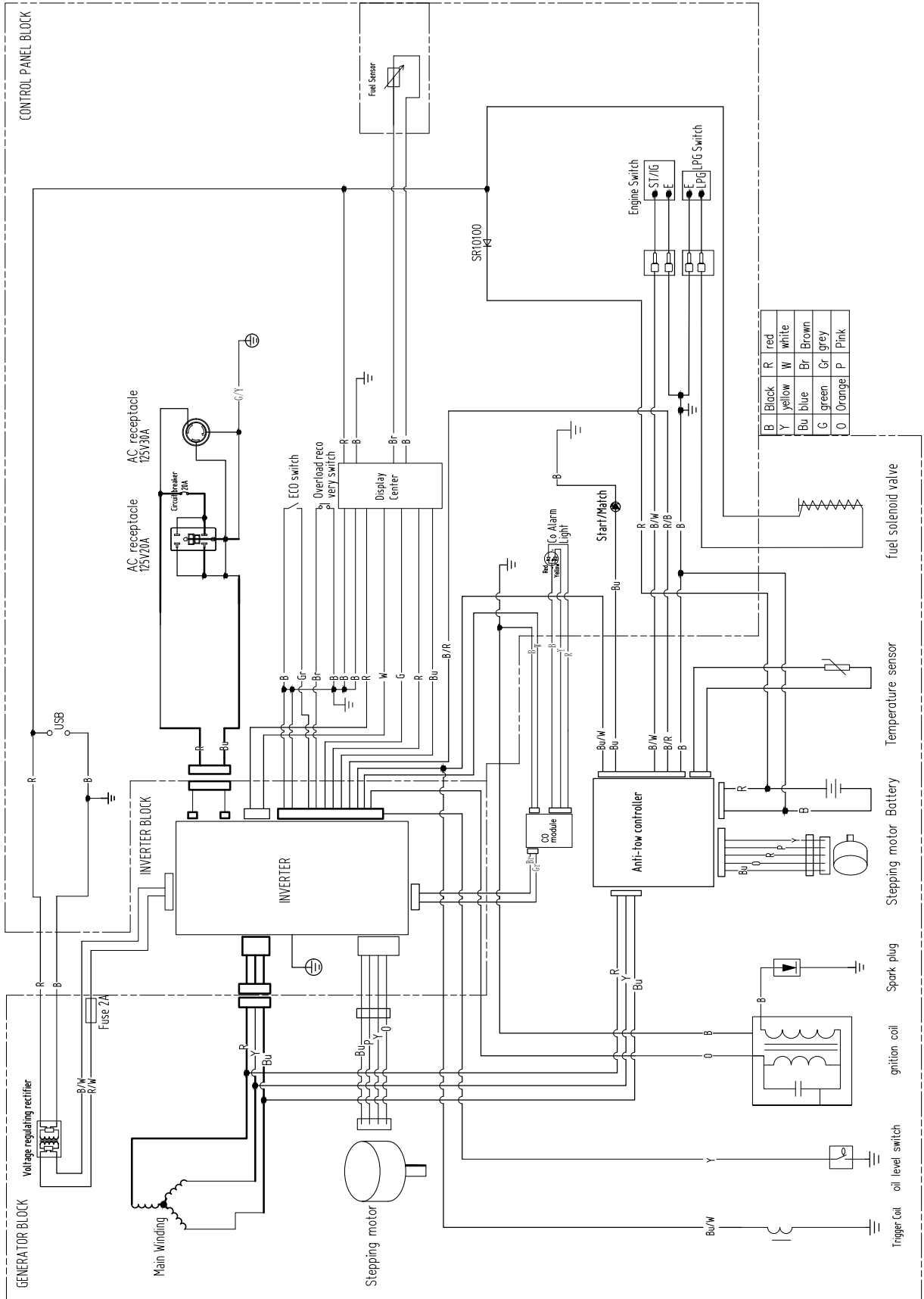

## QUICK REFERENCE WATTAGE

Power Rating	Tool or Appliance	Running Watts	Starting Watts	
<b>5500 – 12,000</b> Running Watts	<b>1200 – 1800</b> Running Watts	Blender	300	650
		Coffee Maker	1500	
		Drill	600	900
		Fan	200	
		Furnace 1/4 hp	600	1000
		Game console	150	
		Hand sander	600	1200
		Hedge trimmer	450	1200
		Lamp	100	
		Laptop	800	
		LED/LCD TV	150	
		Microwave	1000	
		Modem/router	20	
		Paint sprayer	600	600
		Radio	100	
	Slow cooker	200	200	
	String trimmer	350	875	
	Sump Pump 1/3 hp	800	1300	
	Work light	1000		
	<b>2800 – 3800</b> Running Watts	Belt sander	1200	2400
Chainsaw		1200	2400	
Circular saw		1200	2000	
Edger		950	2400	
Electric grill		1650		
Lawn mower		1200	2400	
Pressure washer		1200	2400	
Refrigerator		700	2200	
Washing machine		1150	2250	
Well pump		1000	2100	
Window AC 13k BTU		1800	2800	
Air compressor 1 hp		1600	4500	
Central AC 3 ton		5400	7200	
Electric Dryer		5400	6750	
Heat Pump 3 ton		3400	6500	
Water heater	4000			

†Chart for reference only. Check your device for ACTUAL wattage requirements.

## HOW TO CALCULATE

### Running Watts needed:

Total Running Watts of ALL items to be powered by the generator.

### Starting Watts needed:

Add highest SINGLE Starting Watt to Total Running Watts needed above.

## EXAMPLE

### 1 Calculate Running Watts:

Furnace	600
Lamp	100
Microwave	1000
Refrigerator	700
<b>Total Running Watts</b>	<b>2400</b>

### 2 Calculate Starting Watts:

Total Running Wattage	2400
Refrigerator	2200
<b>Total Starting Watts</b>	<b>4600</b>





In production management, based on orderly, efficient, scientific principles. trying to do as better as possible in product design, development, production, inspection, etc. to make our production can keep orderly. And will continue to make improvement to make sure that keep the competitiveness.

**Welcome friends at home and abroad to visit and guide, work together to create brilliant.**

# GENMAX<sup>®</sup>

**Caojie Industrial Park, Hechuan District, Chongqing**

**Phone** 866-960-2920

**E-mail** warrantiesmallengines@gmail.com

**Http://www.genmaxpower.com/**

